



**Forced Convection
Constant Temperature Oven**

Model

**DNF 400/410/600
610/810/910**

Instruction Manual

- Second Edition -

- Thank you for purchasing "Forced Convection Constant Temperature Oven, DNF Series" of Yamato Scientific Co., Ltd.
- To use this unit properly, read this "Instruction Manual" thoroughly before using this unit. Keep this instruction manual around this unit for referring at anytime.

⚠WARNING!:

Carefully read and thoroughly understand the important warning items described in this manual before using this unit.

Yamato Scientific America, Inc.

◆ Cautions in Using with Safety	1
• Explanation.....	1
• Table of Illustrated Symbols.....	2
• Fundamental Matters of "WARNING!" and "CAUTION!".....	3
◆ Before Using this unit	4
• Requirements for Installation.....	4
◆ Description and Function of Each Part	9
• Main Unit.....	9
• Control Panel.....	12
◆ Operation Method	13
• Key Operation Chart of Mode Setting and Program Registering.....	13
• Operation Mode and Function List.....	14
• Fixed Temperature Operation.....	15
• Auto Stop Operation.....	17
• Auto Start Operation.....	20
• Program Operation.....	22
• Input Program.....	25
• Input Program; Set the Temperature.....	27
• Input Program; Set the Time.....	28
• Input Program; Set the Fan Rotation Speed.....	29
• Input Program; Set the Repeat Initiating Step.....	30
• Input Program; Set the Repeat Count.....	31
• Input Program; Insert Step.....	32
• Input Program; Add Step.....	33
• Input Program; Delete Step.....	34
• Input Program; End Program.....	35
• Program Creation Method.....	36
• Programming Preparation Form.....	42
• Set the Timer Mode.....	43
• Set the Key Lock Mode.....	44
• Set the Buzzer Mode.....	45
• Calibration Offset Function.....	46
• Integrating Operation Time.....	47
• Set Clock.....	48
• Set Fan Operation at Wait State.....	50
• Set the Fan Rotation Speed.....	51
• Set the Communication Lockout Mode (Optional accessory).....	52
• How to Operate the Damper.....	53
• The Independent Overheating Prevention Device.....	54
• Temperature Rise/Fall Data (Reference Data).....	55

◆ Handling Precautions	56
◆ Maintenance Method	57
• Daily Inspection and Maintenance	57
◆ Long storage and disposal	58
• When not using this unit for long term / When disposing.....	58
◆ In the Event of Failure	59
• Safety Device and Error Code	59
• Trouble Shooting	61
◆ After Service and Warranty	62
◆ Specification	63
◆ Wiring Diagram	65
◆ Replacement Parts Table	69
◆ Reference	71
• List of Dangerous Substances	71

Explanation

MEANING OF ILLUSTRATED SYMBOLS

Illustrated Symbols

Various symbols are used in this safety manual in order to use the unit without danger of injury and damage of the unit. A list of problems caused by ignoring the warnings and improper handling is divided as shown below. Be sure that you understand the warnings and cautions in this manual before operating the unit.

 **WARNING!** If the warning is ignored, there is the danger of a problem that may cause a serious accident or even fatality.

 **CAUTION!** If the caution is ignored, there is the danger of a problem that may cause injury/damage to property or the unit itself.

Meaning of Symbols



This symbol indicates items that urge the warning (including the caution). A detailed warning message is shown adjacent to the symbol.



This symbol indicates items that are strictly prohibited. A detailed message is shown adjacent to the symbol with specific actions not to perform.



This symbol indicates items that should be always performed. A detailed message with instructions is shown adjacent to the symbol.

Table of Illustrated Symbols

Warning



Warning, generally



Warning, high voltage



Warning, high temperature



Warning, drive train



Warning, explosive

Caution



Caution, generally



Caution, electrical shock



Caution, scald



Caution, no road heating



Caution, not to drench



Caution, water only



Caution, deadly poison

Prohibit



Prohibit, generally



Prohibit, inflammable



Prohibit, to disassemble



Prohibit, to touch

Compulsion



Compulsion, generally



Compulsion, connect to the grounding terminal



Compulsion, install on a flat surface



Compulsion, disconnect the power plug



Compulsion, periodical inspection

Cautions in Using with Safety

Fundamental Matters of "WARNING!" and "CAUTION!"

WARNING!

Do not use this unit in an area where there is flammable or explosive gas

Never use this unit in an area where there is flammable or explosive gas. This unit is not explosion-proof. An arc may be generated when the power switch is turned on or off, and fire/explosion may result. (Refer to page 71 "List of Dangerous Substances".)

Always ground this unit

Always ground this unit on the power equipment side in order to avoid electrical shock due to a power surge.

If a problem occurs

If smoke or strange odor should come out of this unit for some reason, turn off the power key right away, and then turn off the circuit breaker and the main power. Immediately contact a service technician for inspection. If this procedure is not followed, fire or electrical shock may result. Never perform repair work yourself, since it is dangerous and not recommended.

Do not use the power cord if it is bundled or tangled

Do not use the power cord if it is bundled or tangled. If it is used in this manner, it can overheat and fire may be caused.

Do not process, bend, wring, or stretch the power cord forcibly

Do not process, bend, wring, or stretch the power cord forcibly. Fire or electrical shock may result.

Substances that can not be used

Never use explosive substances, flammable substances and substances that include explosive or flammable ingredients in this unit. Explosion or fire may occur. (Refer to page 71 "List of Dangerous Substances".)

Do not disassemble or modify this unit

Do not disassemble or modify this unit. Fire or electrical shock or failure may be caused.

Do not touch high-temperature parts

The inside of the body or the door may become hot during and just after operation. It may cause burns.

CAUTION!

During a thunder storm

During a thunderstorm, turn off the power key immediately, then turn off the circuit breaker and the main power. If this procedure is not followed, fire or electrical shock may be caused.

Requirements for Installation

WARNING!

1. Always ground this unit



- The DNF400 and DNF600 types use a 115V power source.



- The DNF600 type does not contain a power plug. Please consult your local electrical contractor for power connecting work.
- The DNF410, DNF610, DNF810 and DNF910 types use a single-phase 220V power source. Please consult your local electrical contractor for power connecting work.
- Be sure to connect the earth wire (the green cable of power cord) to the grounding conductor or ground terminal to prevent accidents caused by electric leakage.
- Do not connect the earth wire to gas or water pipes. If not, fire disaster may be caused.
- Do not connect the earth wire to the ground for telephone wire or lightning conductor. If not, fire disaster or electric shock may be caused.
- Do not use a branching receptacle, which may cause the heat generation.

2. Choose a proper place for installation



- Do not install this unit in a place where:
 - ◆ Rough or dirty surface.
 - ◆ Flammable gas or corrosive gas is generated.
 - ◆ Ambient temperature exceeds 35°C.
 - ◆ Ambient temperature fluctuates violently.
 - ◆ There is direct sunlight.
 - ◆ There is excessive humidity and dust.
 - ◆ There is a constant vibration.



- Install this unit on a stable place with the space as shown below. The exhausted opening is provided on the back surface. Keep away from it during operation.

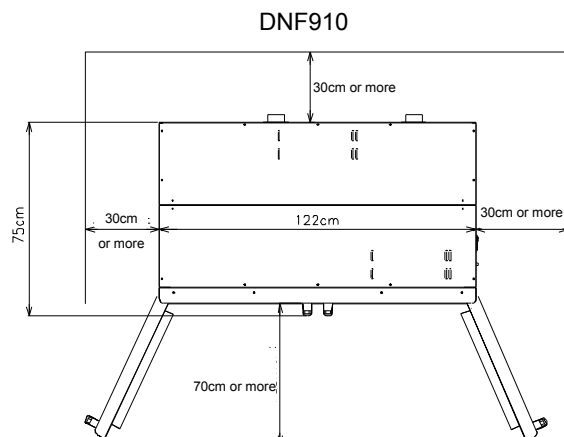
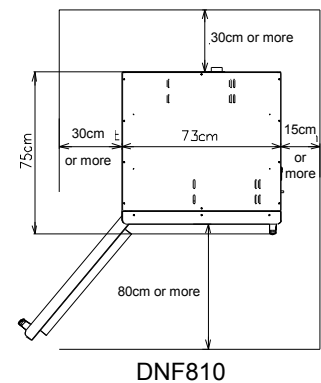
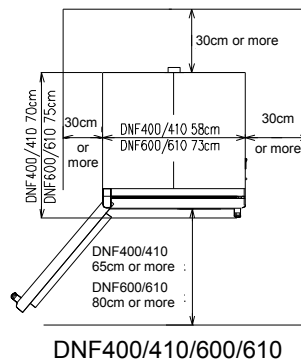

Requirements for Installation

3. Do not use this unit in an area where there is flammable or explosive gas

(Refer to page 71 "List of Dangerous Substances".)



- Never use this unit in an area where there is flammable or explosive gas. This unit is not explosion-proof. An arc may be generated when the power switch is turned ON or OFF, and fire/explosion may result.

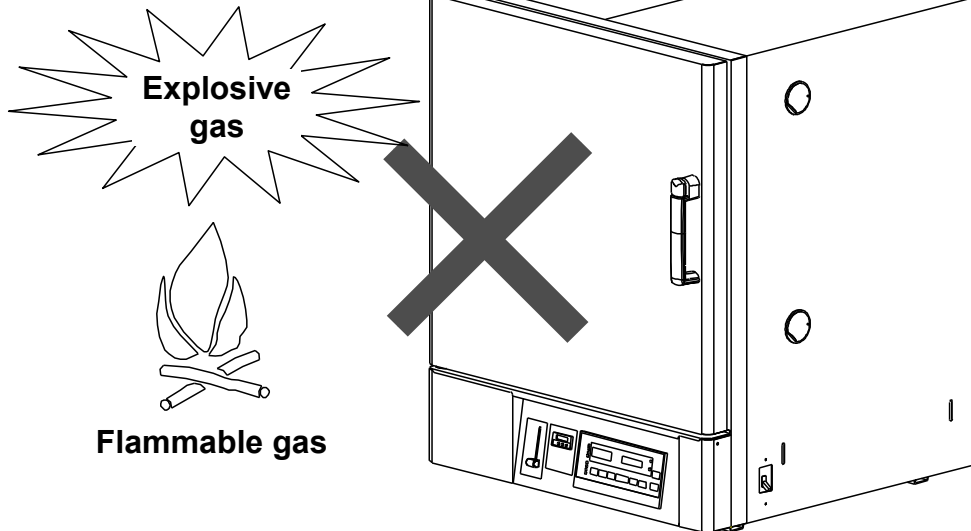

- Never use explosive substances, flammable substances and substances that include explosive or flammable ingredients in this unit. Explosion or fire may occur.

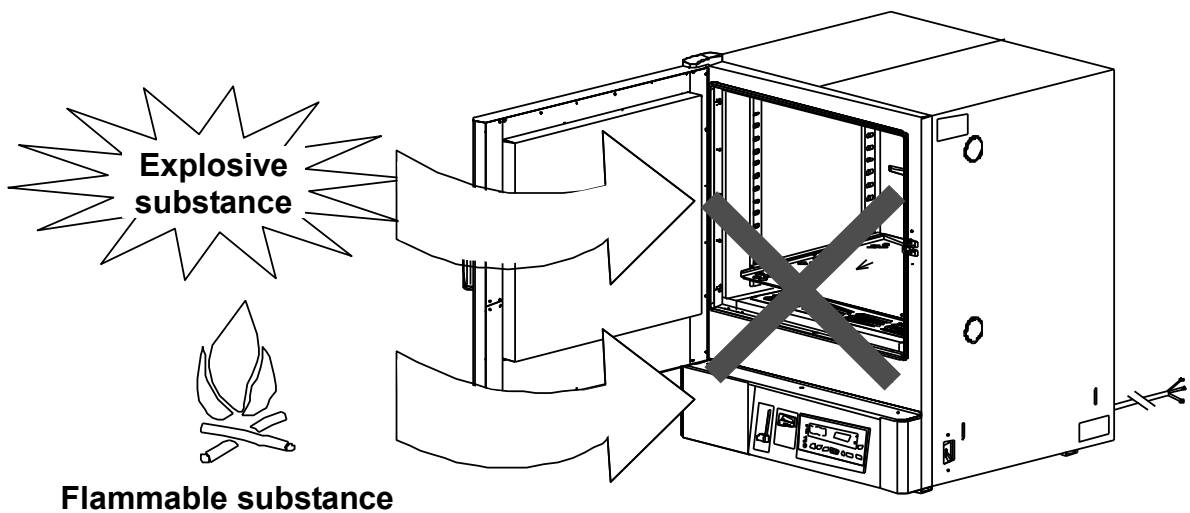

Requirements for Installation

4. Do not modify



- Modification of this unit is strictly prohibited. This could cause a failure.

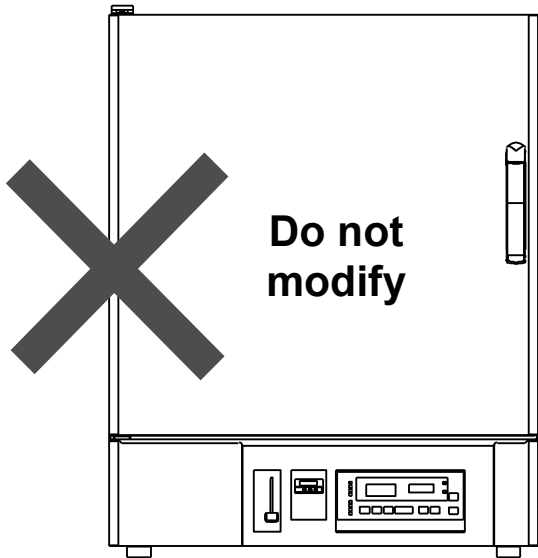

5. Installation on horizontal surface



- Set this unit to the flattest place. Setting this unit on rough or slope place could cause the vibration or noise, or cause the unexpected trouble or malfunction.

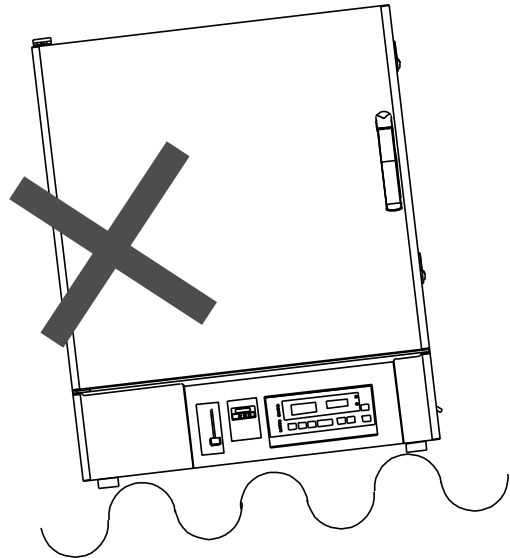

CAUTION!

6. Do not make an overload



- The withstand load of shelf is 15kg (uniform load) Set the samples apart each other.



7. Do not set samples in close formation



- The temperature in furnace cannot be controlled if too much samples are set there. Make sure to use the shelf and set samples apart each other so as to make the free space of 30% or more to the furnace to acquire accuracy of temperature.

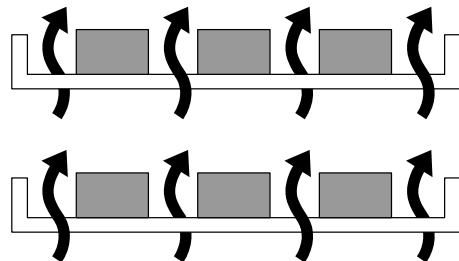

Make the free space of 30% or more

Requirements for Installation

8. Do not use corrosive sample



- Stainless steel SUS304 is used for the main hot-air path; however, it may be corroded by strong acid etc. And the door packing made of silicon rubber may be corroded by some kind of solvent, e.g. alkaline, oil, halogen etc. Do not use the sample includes those.

9. Choose a correct power distribution board or receptacle



- Choose a correct power distribution board or receptacle that meets the unit's rated electric capacity.

Electric capacity:

DNF400: 115V AC, 11.5A

DNF410: 1 ϕ 220V AC, 6A

DNF810: 1 ϕ 220V AC, 13A

DNF600: 115V AC, 13.5A

DNF610: 1 ϕ 220V AC, 7A

DNF910: 1 ϕ 220V AC, 15.5A

NOTE)

There could be the case that the unit does not run even after turning ON the power. Inspect whether the voltage of the main power is lowered than the specified value, or whether other device(s) uses the same power line of this unit. If the phenomena might be found, change the power line of this unit to the other power line. Please consult your dealer or a local electrical contractor for the connection of DNF600 and devices that use a single-phase 200V power source.

10. Handling of power code



- Do not entangle the power cord. This will cause overheating and possibly a fire.
- Do not bend or twist the power cord, or apply excessive tension to it. This may cause a fire and electrical shock.
- Do not lay the power cord under a desk or chair, and do not allow it to be pinched in order to prevent it from being damaged and to avoid a fire or electrical shock.
- Keep the power cord away from any heating equipment such as a room heater. The cord's insulation may melt and cause a fire or electrical shock.



- If the power cord becomes damaged (wiring exposed, breakage, etc.), immediately turn off the power at the rear of this unit and shut off the main supply power. Then contact your nearest dealer for replacement of the power cord. Leaving it may cause a fire or electrical shock.
- Connect the power plug to the receptacle which is supplied appropriate power and voltage.

11. Before/after installing



- It may cause injure to a person if this unit falls down or moves by the earthquake and the impact. etc..To prevent, take measures that the unit cannot fall down, and not install to busy place.
- Touching the unit may cause a burn during and just after the operation. To prevent, take measures that putting up a notice of operating etc..
- Make sure to lock the caster for DNF810 and DNF910 types.

Requirements for Installation

12. Setting of the shelf and sample



• The number of shelves attached varies depending on the type of product (2 to 8). One of them (two for DNF910) is previously fixed on the lowermost stand of bracket supporter with screws at factory shipment. Set the other shelves in place in furnace as necessary.



• One of the shelves is fixed on the lowermost stand of bracket supporter with screws at factory shipment. The temperature of the current plate and its adjacence is usually higher than the setting temperature because the heater is provided under it, which may cause burn of sample or fire disaster if the sample is directly put on the current plate. Do not shut the slit on near side of current plate with samples because it is an inlet slit on the circuration circuit of hot air, with samples. To prevent such accidents, the shelf is fixed with a screw as shown in the figure. Be sure to provide sufficient space between the current plate and sample in case the shelf must be removed due to the shape of sample. Do not put the sample directly on the current plate.

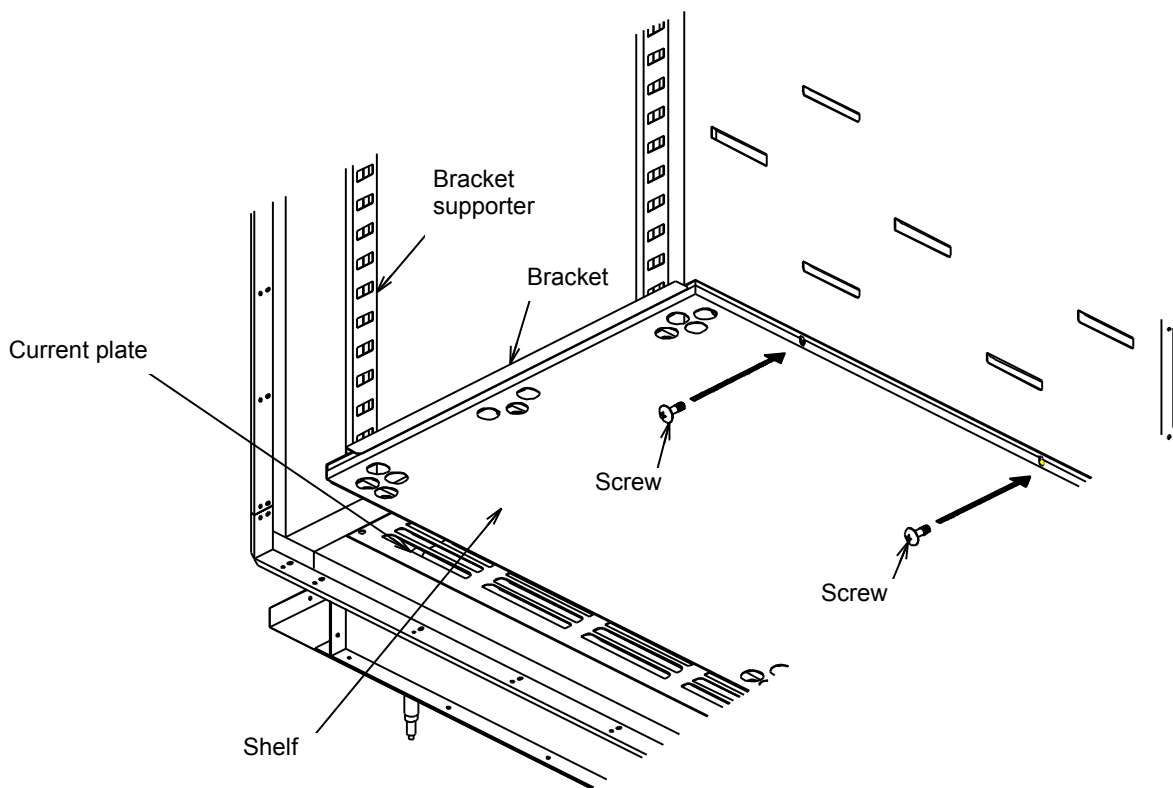

Description and Function of Each Part

Main Unit

DNF400/410/600/610

Front view

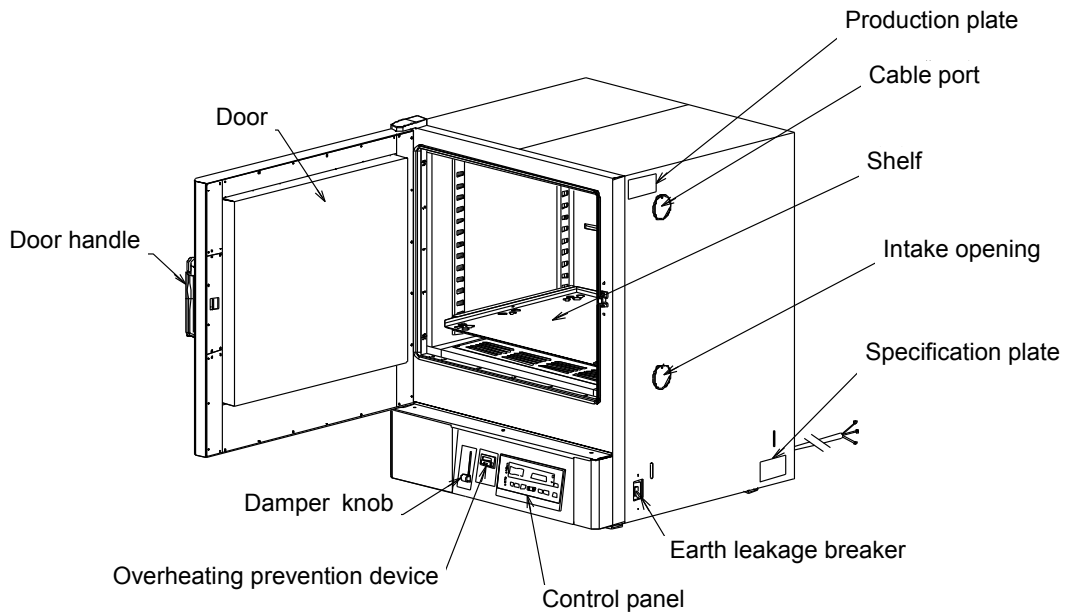

Rear view

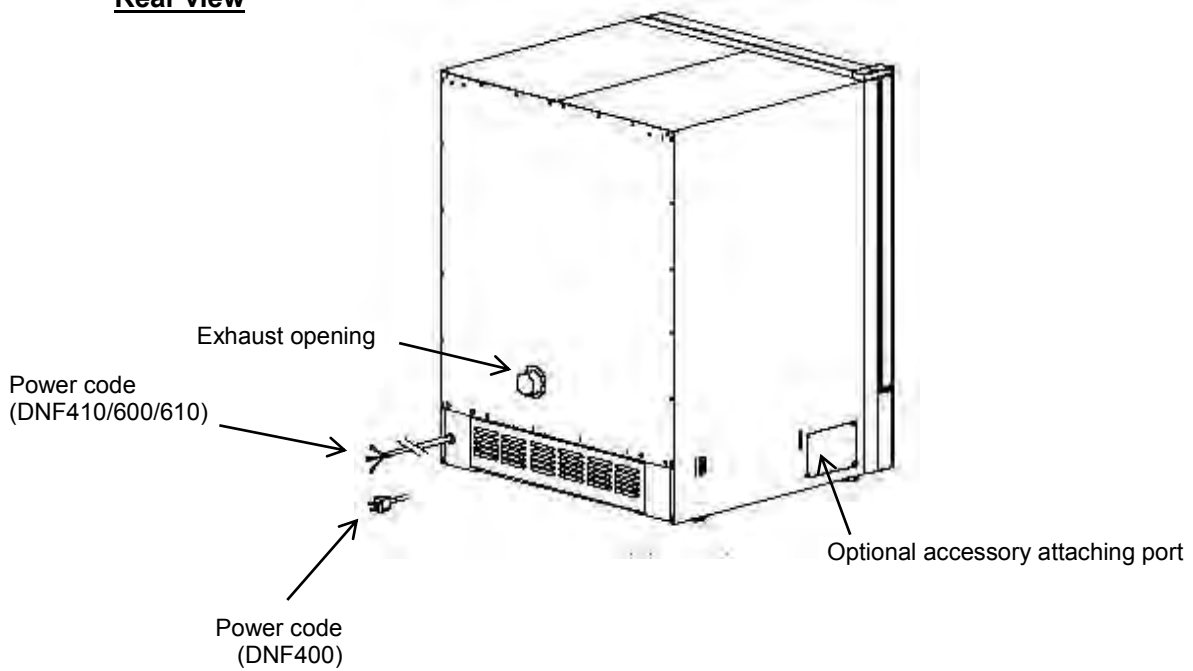

Description and Function of Each Part

Main Unit

DNF810

Front view

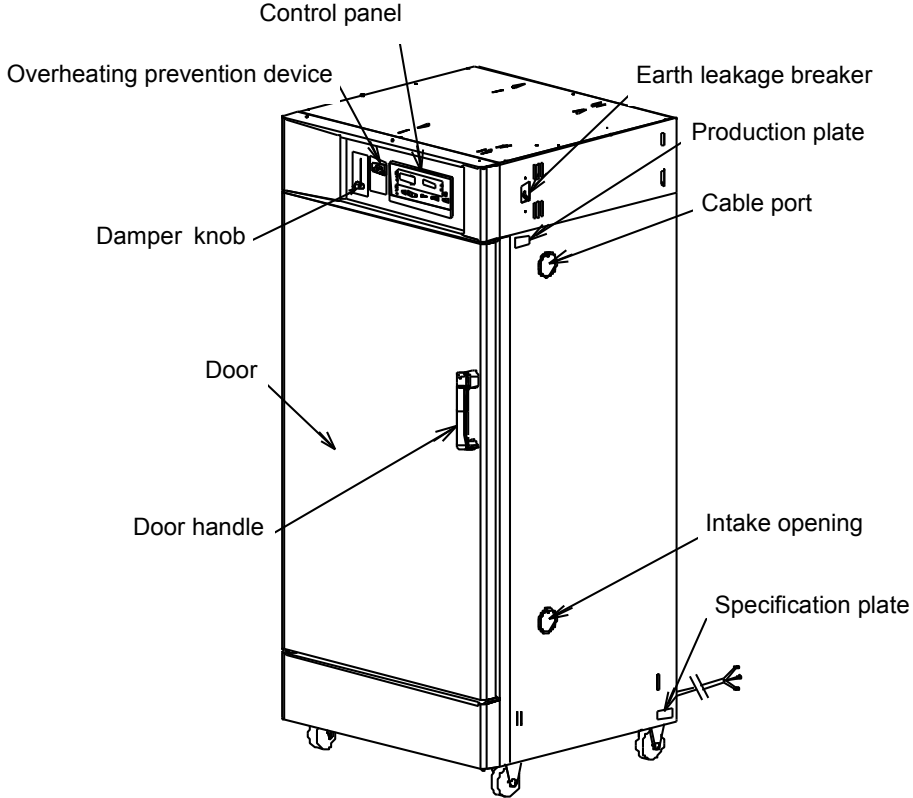

Rear view

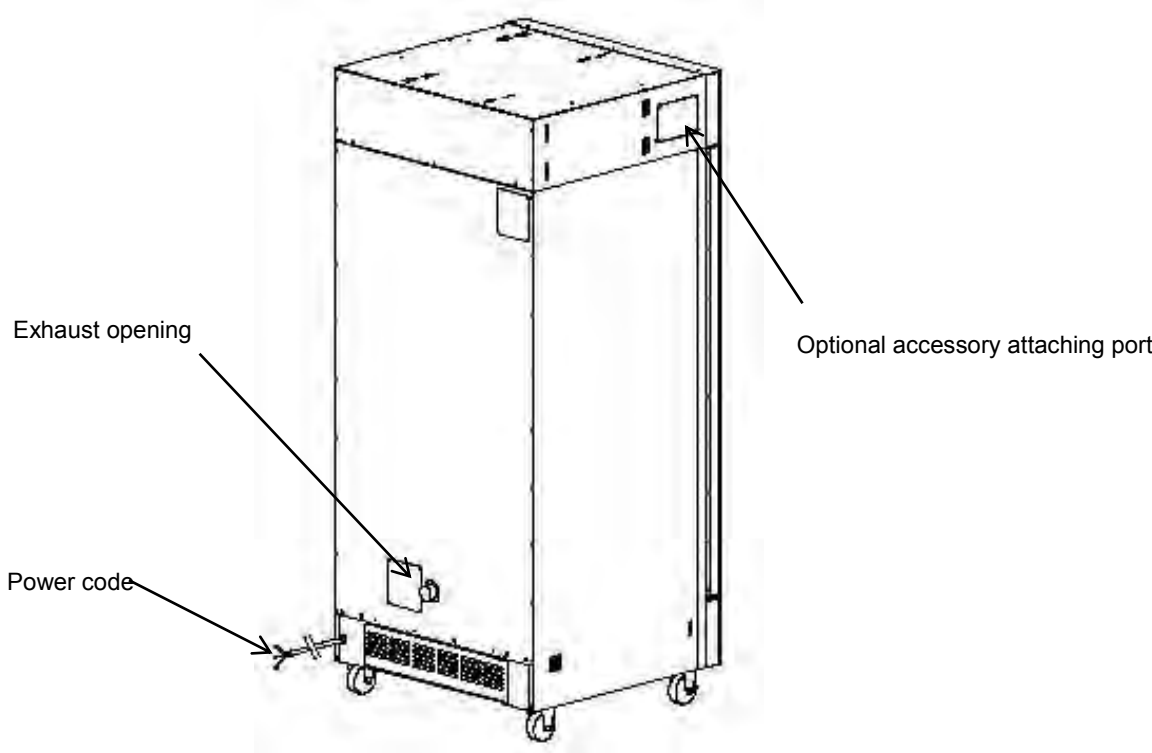

Description and Function of Each Part

Main Unit

DNF910

Front view

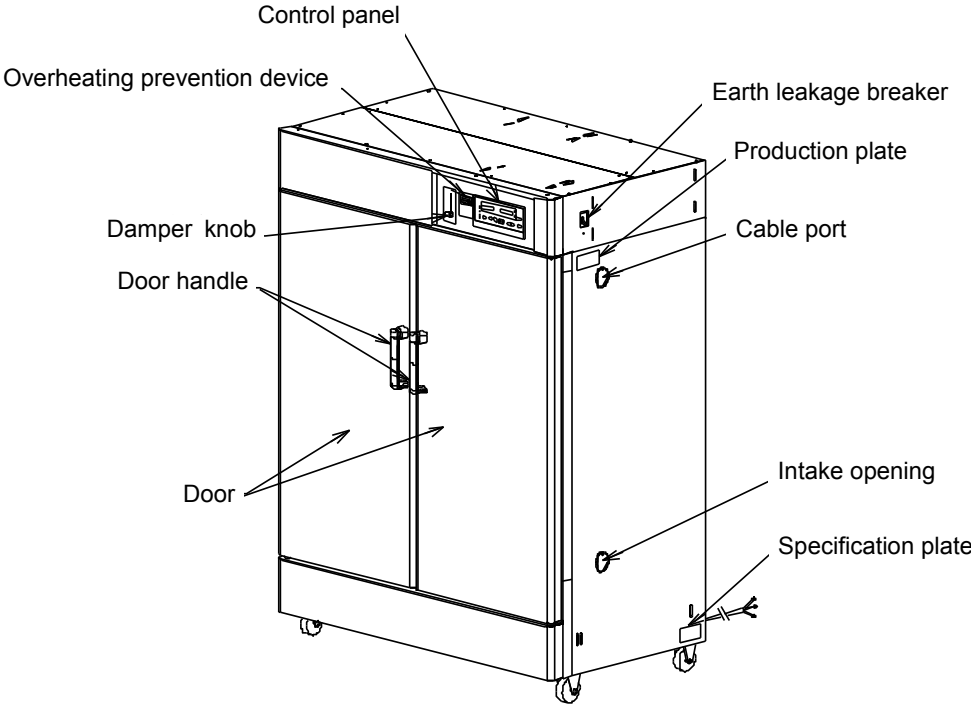

Rear view

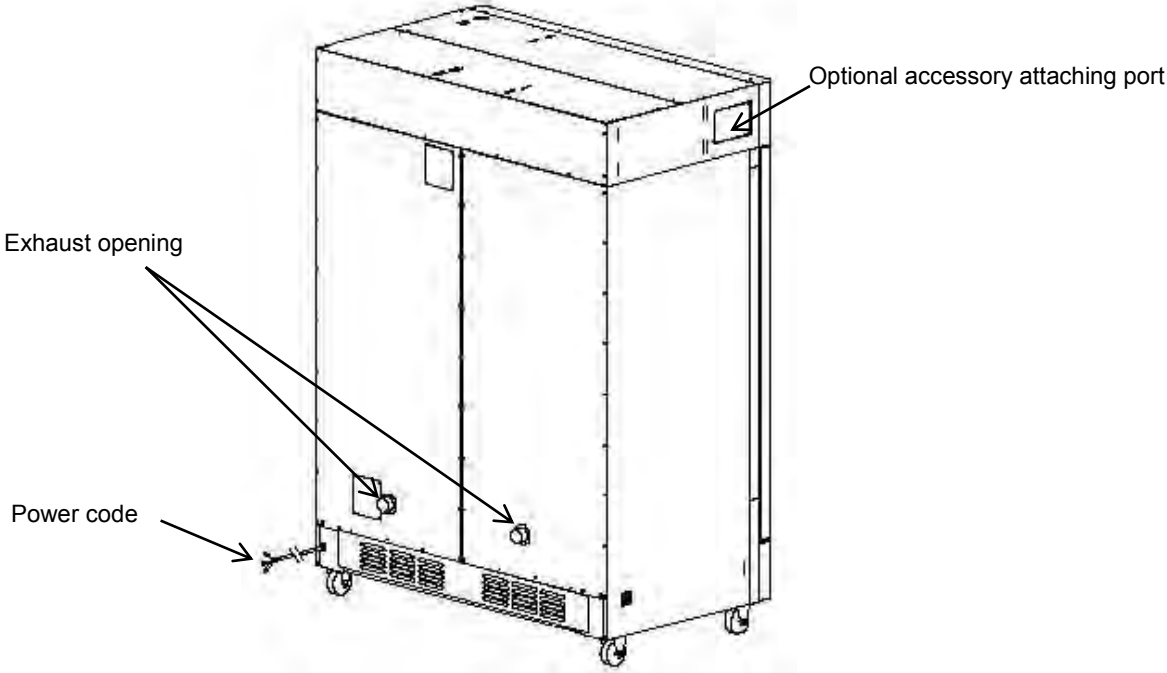

Description and Function of Each Part

Control Panel

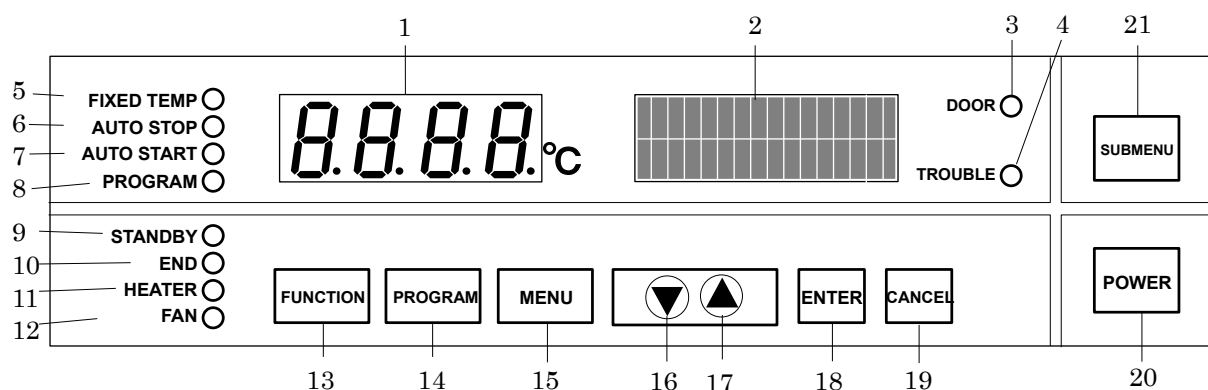

1	Main Display :	Displays the measured temperature and error code.
2	Sub Display :	Displays the operation and setting information.
3	DOOR lamp :	Lights while the door is opened. (Disabled in this unit.)
4	TROUBLE Lamp :	Blinks when a trouble occurs.
5	FIXED TEMP lamp :	Lights while the fixed temperature operation is running. Blinks while the choosing operation mode.
6	AUTO STOP Lamp :	Lights while the auto stop operation is running. Blinks while choosing the operation mode.
7	AUTO START Lamp :	Lights while the auto start operation is running. Blinks while choosing the operation mode.
8	PROGRAM Lamp :	Lights while the program operation is running. Blinks while choosing the operation mode.
9	STANDBY Lamp :	Lights while the device is in standby state. Blinks while the device is in startup wait state.
10	END Lamp :	Blinks at end of the autostop or program operation.
11	HEATER Lamp :	Lights while the heater works.
12	FAN Lamp :	Lights while the fan works.
13	FUNCTION Key :	Starts the function menu.
14	PROGRAM Key :	Starts the program menu.
15	MENU Key :	Starts the operation menu.
16	▼(Down) Key :	Lowers down the setting value.
17	▲(Up) Key :	Rises up the setting value.
18	ENTER Key :	Settles the inputted value/item.
19	CANCEL Key :	Cancels the current inputting.
20	POWER Key :	Turns ON/OFF the power.
21	SUBMENU Key :	Used for operation with the optional accessory.

Key Operation Chart of Mode Setting and Program Registering

► Operation procedure

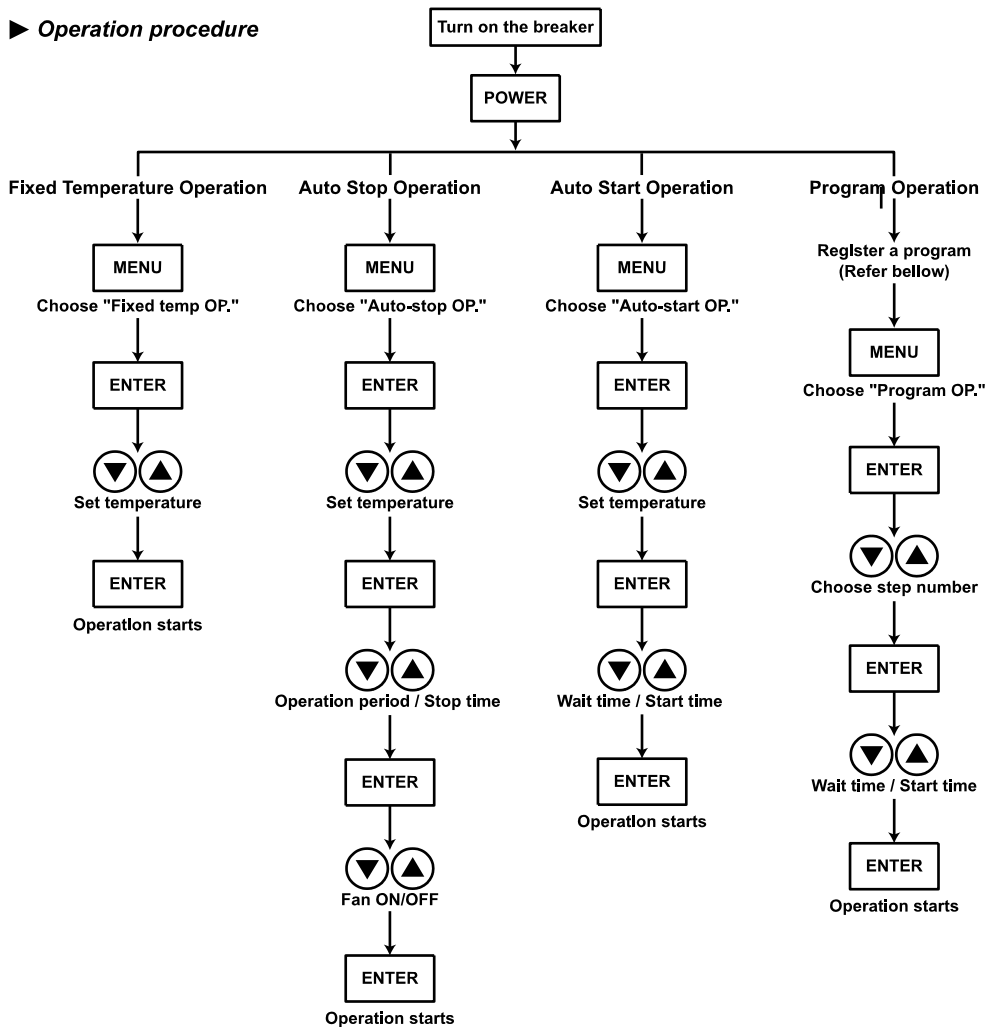

► How to register a program

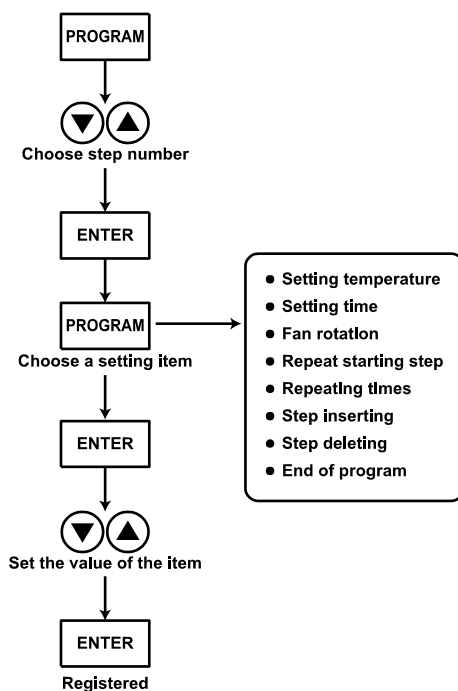

CANCEL	Pressing the CANCEL key cancels current Inputting.
POWER	Pressing the POWER key stops the operation.

- Setting temperature
- Setting time
- Fan rotation
- Repeat starting step
- Repeating times
- Step inserting
- Step deleting
- End of program

Operation Mode and Function List

The operation mode consists of the following four modes.

No.	Name	Description	Page
1.	Fixed Temperature Operation	Controls temperature with fixed temperature.	15
2.	Auto Stop Operation	Stops operation at specified time.	17
3.	Auto Start Operation	Starts operation at specified time.	20
4.	Program Operation	Starts program operation at specified time.	22

The function menus are listed below.

Name	Function	Page
Timer Mode	Sets timer mode.	43
Key Lock Mode	Sets key lock mode.	44
Buzzer Mode	Sets buzzer mode.	45
Calibration Offset	Sets calibration offset temperature.	46
Integrating Operation Time	Displays integrating operation time.	47
Date/Time	Sets date and time.	48
Fan in Standby State	Sets start/stop of fan in standby state.	50
Fan Rotation Speed	Sets fan rotation speed.	51
Communication Lockout Mode (Optional)	Sets communication lockout mode.	52

Fixed Temperature Operation

Start the operation from turning on the power shown in the figure, and continue the operation under the setting temperature unless turning off the power.

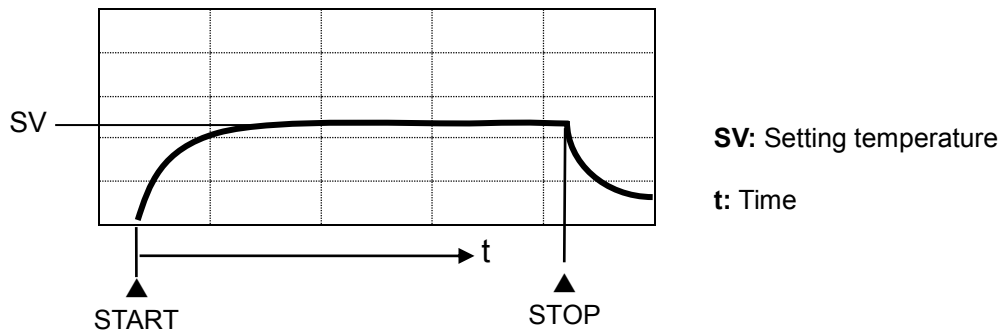

Setting of the Fixed Temperature Operation

1 Turn on the power

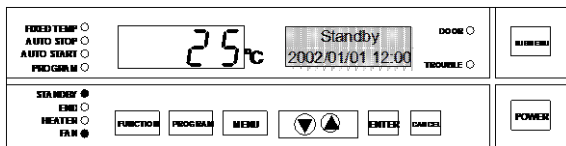
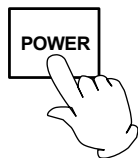

- Turn on the power switch of the unit (earth leakage breaker). Pressing the POWER key turns on the power. The Main Display indicates the temperature in furnace. The Sub Display indicates "Standby" and the STANDBY lamp lights on. (Hereafter, this state is called the "standby state".)
- The FAN lamp lights on and the fan rotates when "Standby" is displayed. Refer to the page 50 to stop the rotation of fan.

2 Select operation mode

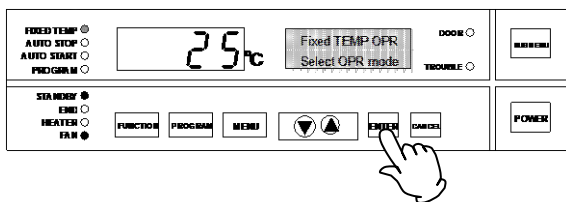
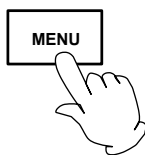

- ① Pressing the MENU key displays the operation mode selection screen.
 - ② The Sub Display on the operation mode selection screen displays the name of operation mode currently selected with blinking. The corresponding operation mode lamp blinks at the same time.
 - ③ Keep pressing the MENU key until the fixed temperature operation mode is displayed.
 - ④ Press the ENTER key. The fixed temperature operation mode is decided.
- ❖ The fixed temperature operation is selected at the initial setting of unit. The operation mode carried out last is selected in case other than it.

Fixed Temperature Operation

3 Set temperature

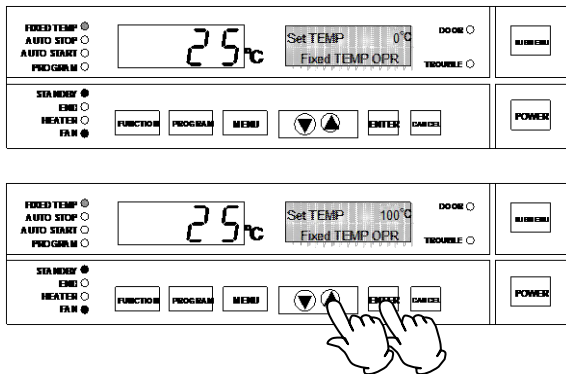

- ① The setting temperature input screen is displayed. The Sub Display indicates "Set TEMP" and the numeric character that indicates temperature blinks.
- ② Set the temperature using the "▲▼".
- ③ Press the ENTER key to decide the temperature and start the fixed temperature operation.

4 Start operation

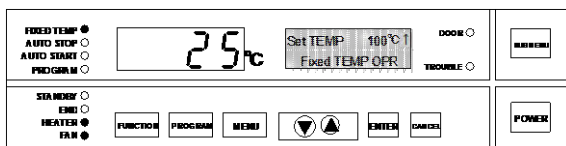

- ① The blinking FIXED TEMP lamp lights on when the fixed temperature operation starts. The unit starts to control temperature according to the setting temperature. The HEATER lamp lights on when the heater is on.
- ② The Sub Display displays the setting temperature. The arrow which indicates the state of temperature control is also displayed with blinking. The direction of arrow shows as follows depending on the relation between the setting temperature at operation start and that in furnace.

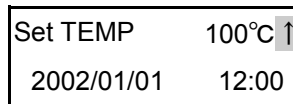

(When setting temperature is higher than temperature in furnace)

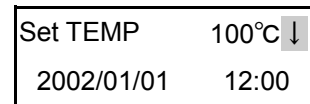

(When setting temperature is lower than temperature in furnace)

- ③ The direction of arrow shows as shown below when the temperature in furnace reaches to within -3 to 6°C of setting temperature.

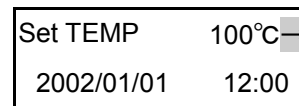

(When temperature in furnace reaches to around setting temperature)

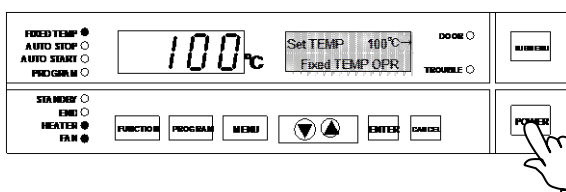

- ④ Press the POWER key to stop operation.

Auto Stop Operation

As shown in the following figure, the device stops operating automatically by setting the timer.

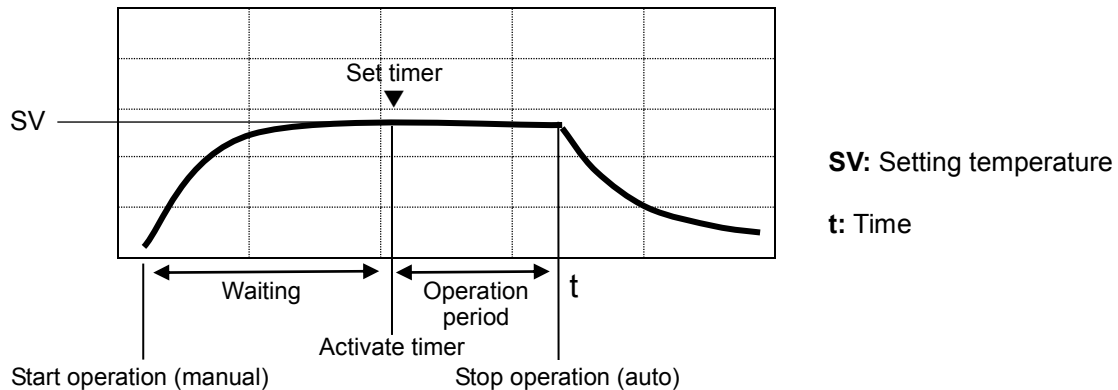

Setting of the Auto Stop Operation

1 Turn on the power

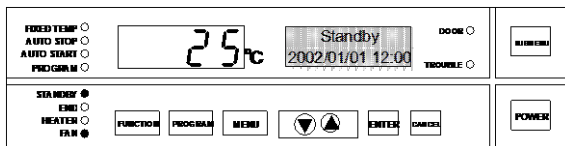
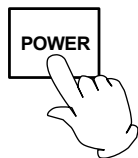

- Turn on the power switch of the unit (earth leakage breaker). Pressing the POWER key turns on the power. The Main Display indicates the temperature in furnace. The Sub Display indicates "Standby" and the STANDBY lamp lights on. (Hereafter, this state is called the "standby state".)
- The FAN lamp lights on and the fan rotates when "Standby" is displayed. Refer to the page 50 to stop the rotation of fan.

2 Select operation mode

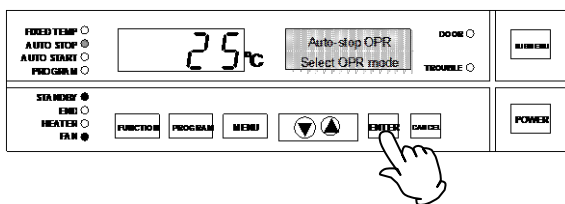
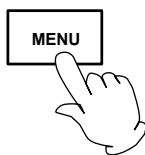

- ① Pressing the MENU key displays the operation mode selection screen.
 - ② The Sub Display on the operation mode selection screen displays the name of operation mode currently selected with blinking. The corresponding operation mode lamp blinks at the same time.
 - ③ Keep pressing the MENU key until the auto stop operation mode is displayed.
 - ④ Press the ENTER key. The auto stop operation mode is decided.
- ❖ The fixed temperature operation is selected at the initial setting of unit. The operation mode carried out last is selected in case other than it.

Auto Stop Operation

3 Set temperature, operation period/stop time, and fan

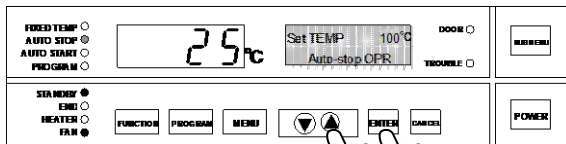
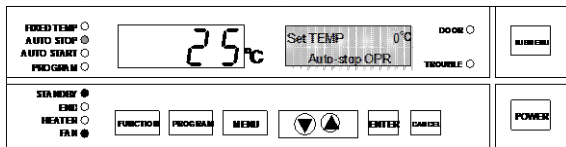

① The setting temperature input screen is displayed. The Sub Display indicates "Set TEMP" and the numeric character that indicates temperature blinks.

② Set the temperature using the "▲▼".

③ Press the ENTER key to decide the temperature.

④ The operation period/stop time input screen is displayed after the setting temperature is decided.

Display the period/time using the "▲▼". Input the operation period when the setting of timer mode shows "Time". Input the operation stop time when it shows "Clock".

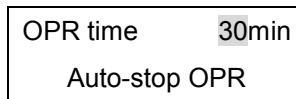

(Operation period edition screen)

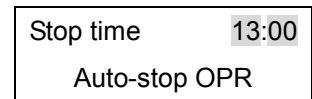

(Operation stop time edition screen)

- The display style of operation period varies depending on the range of time to be displayed.

Time Range	Indication
0minute to 59minutes	0min to 59min
1hour to 99hours59minutes	1h00m to 99h59m

- The input range of operation stop time is always from 0:00 to 23:59.

⑤ Press the ENTER key to decide the period/time.

⑥ The screen returns to the fan function input screen after the period/time is decided. Select "On" or "Off" using the "▲▼".



(Fan function selection screen)

Auto Stop Operation

4 Start operation

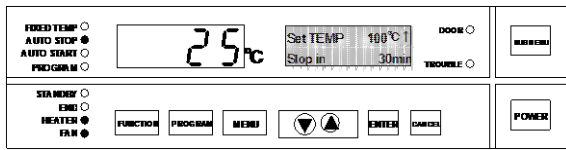

① Press the ENTER key to decide the setting and the auto stop operation starts. The blinking AUTO STOP lamp lights on and the Sub Display displays the setting temperature and residual time to operation stop.

② The countdown of timer is suspended when the temperature in furnace is 3°C or more lower than the setting temperature, or 6°C or more higher than it. In this case, the Sub Display displays "Wait" with blinking. The time display on the right side of "Wait" shows the total waiting time in operation.

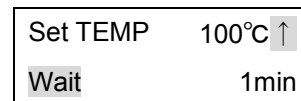

(Waiting screen)

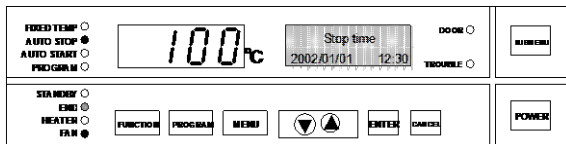

③ The operation stops when the residual time counts zero. The END lamp blinks and the Sub Display displays the operation finish time when the operation stops.

❖ The wait function is not activated when the auto stop operation is carried out with "Clock" mode. The operation stops at specified time.

④ The fan stops at the same time the operation finishes when "OFF" is selected at fan function.

❖ The setting of fan function ["ON"/"OFF"] takes priority, regardless of setting for fan operation in the standby state.

⑤ Press the POWER key to quit operation.

Auto Start Operation

As shown in the following figure, this mode is applied to the device for starting the operation after the specified time (hours) automatically. Note that the device does not stop the operation automatically. Stop the operation by manual without fail.

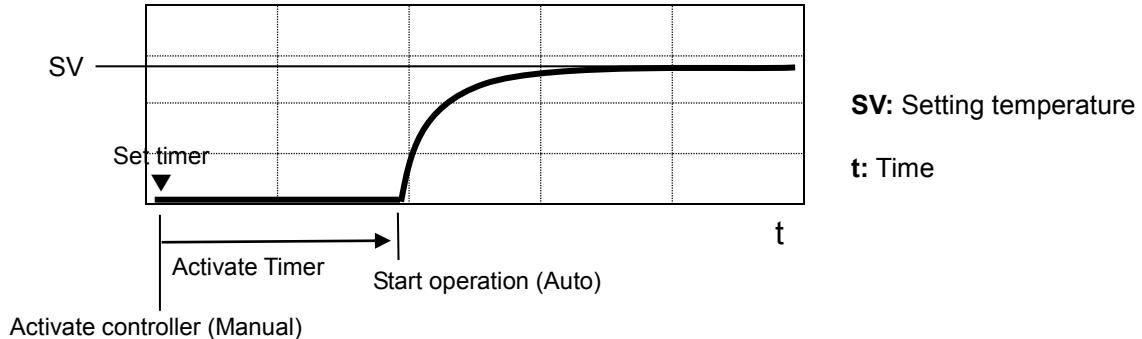

Setting of the Auto Start Operation

1 Turn on the power

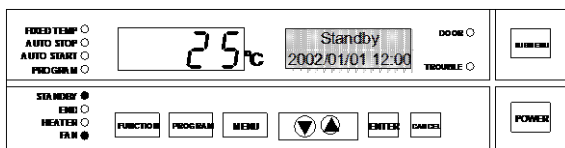
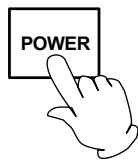

- Turn on the power switch of the unit (earth leakage breaker). Pressing the POWER key turns on the power. The Main Display indicates the temperature in furnace. The Sub Display indicates "Standby" and the STANDBY lamp lights on. (Hereafter, this state is called the "standby state".)
- The FAN lamp lights on and the fan rotates when "Standby" is displayed. Refer to the page 50 to stop the rotation of fan.

2 Select operation mode

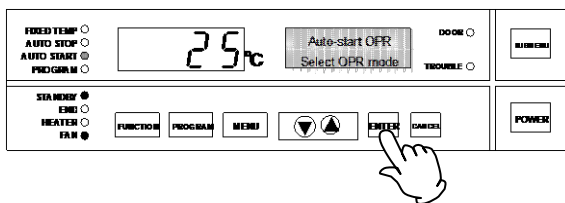
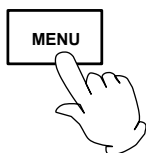

- ① Pressing the MENU key displays the operation mode selection screen.
 - ② The Sub Display on the operation mode selection screen displays the name of operation mode currently selected with blinking. The corresponding operation mode lamp blinks at the same time.
 - ③ Keep pressing the MENU key until the auto start operation mode is displayed.
 - ④ Press the ENTER key. The auto start operation mode is decided.
- ❖ The fixed temperature operation is selected at the initial setting of unit. The operation mode carried out last is selected in case other than it.

Auto Start Operation

3 Set temperature and start wait period/time

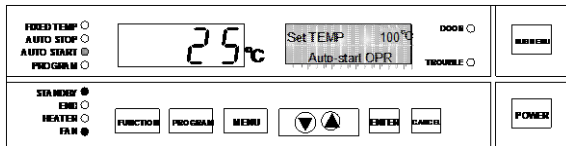
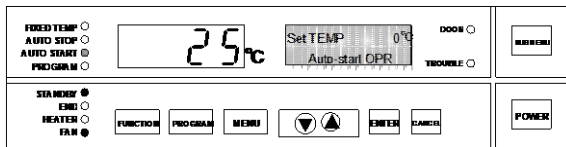

- ① The setting temperature input screen is displayed. The Sub Display indicates "Set TEMP" and the numeric character that indicates temperature blinks.
- ② Set the temperature using the "▲▼".
- ③ Press the ENTER key to decide the temperature.
- ④ The operation start wait period/time input screen is displayed after the setting temperature is decided. Display the operation start wait period/time using the "▲▼". Input the operation start wait period when the setting of timer mode shows "Time". Input the operation start time when it shows "Clock".

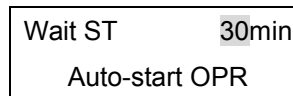

(Operation start wait period edition screen)

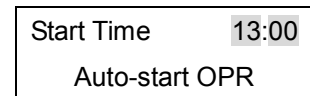

(Operation start time edition screen)

- The display style of operation start wait period varies depending on the range of time to be displayed.

Time Range	Indication
0minute to 59minutes	0min to 59min
1hour to 99hours59minutes	1h00m to 99h59m

- The input range of operation start time is always from 0:00 to 23:59.

4 Start operation

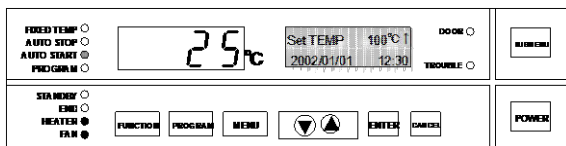
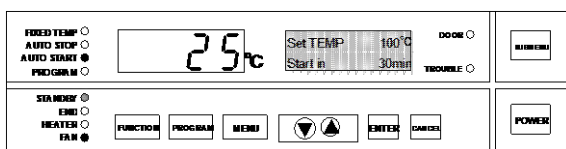

- ① Press the ENTER key to decide the operation start wait period/time. The unit enters to auto start operation wait state. The blinking AUTO START lamp lights on and the STANDBY lamp blinks instead in this state. The fan rotates or stops according to the setting of "Fan (standby)". The Sub Display displays the setting temperature and residual time to operation start.
- ② The operation starts when the residual time counts zero. The STANDBY lamp lights off and the Sub Display displays the same subject as in the fixed temperature operation after the operation starts.
- ③ Press the POWER key to cancel or quit the wait state.

Program Operation

As shown in the figure, this mode is used for running the device under the setting program.

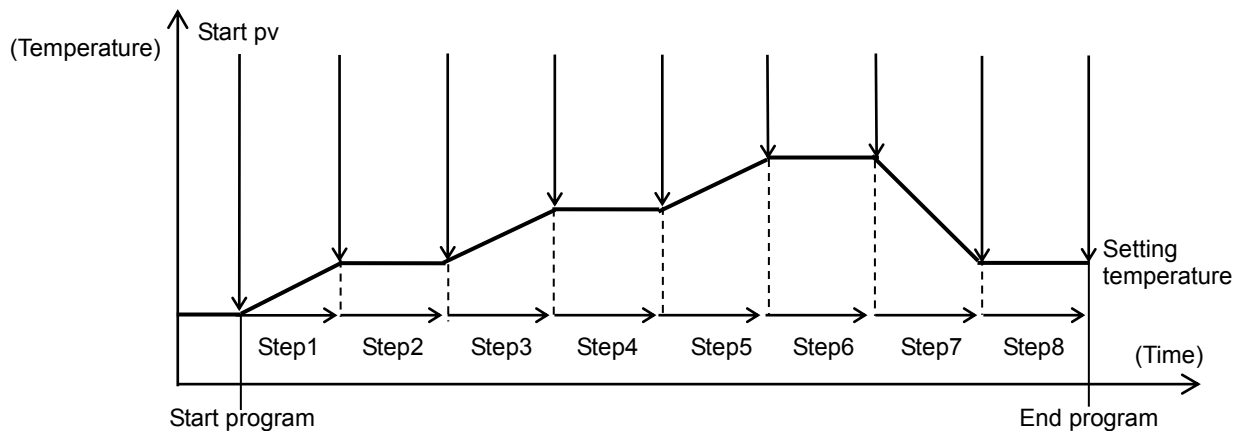

Setting of the Program Operation

1 Turn on the power

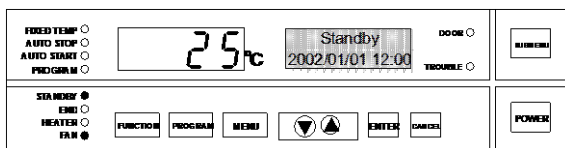
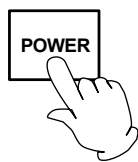

- Turn on the power switch of the unit (earth leakage breaker). Pressing the POWER key turns on the power. The Main Display indicates the temperature in furnace. The Sub Display indicates "Standby" and the STANDBY lamp lights on. (Hereafter, this state is called the "standby state".)
- The FAN lamp lights on and the fan rotates when "Standby" is displayed. Refer to the page 50 to stop the rotation of fan.

❖ Program registration using PROGRAM key is necessary before starting program operation.

2 Select operation mode

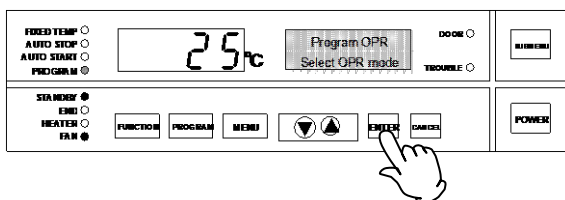
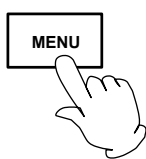

- ① Pressing the MENU key displays the operation mode selection screen.
 - ② The Sub Display on the operation mode selection screen displays the name of operation mode currently selected with blinking. The corresponding operation mode lamp blinks at the same time.
 - ③ Keep pressing the MENU key until the program operation mode is displayed.
 - ④ Press the ENTER key. The program operation mode is decided.
- ❖ The fixed temperature operation is selected at the initial setting of unit. The operation mode carried out last is selected in case other than it.

Program Operation

3 Set step number and start wait period/time

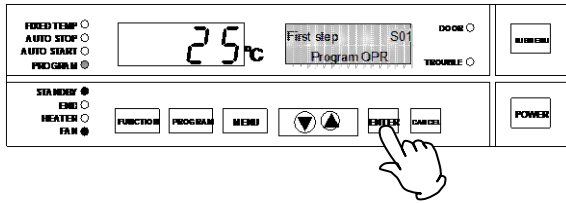

- ① The initiating step input screen is displayed. The Sub Display displays "First step" and the step number blinks.
 - ② Select the step number using the "▼▲" and then check it using the ENTER key.
- ❖ The "steps that are not set" and "step within repeat" are not displayed. If no program is registered (no steps are used), the buzzer sounds with a message on the Sub Display. In this case, register program using the PROGRAM key and start the step again.

NO program

Registered

(Display in case no program is registered)

- ③ The operation start wait period/time input screen is displayed after the step number is decided. Display the operation start wait period/time using the "▲▼".
Input the operation start wait period when the setting of timer mode shows "Time". Input the operation start time when it shows "Clock".

Wait ST 30min
Program OPR

(Operation start wait period edition screen)

Start Time 13:00
Program OPR

(Operation start time edition screen)

Program Operation

4 Start operation

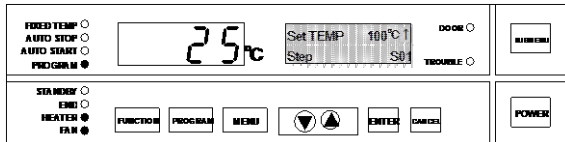
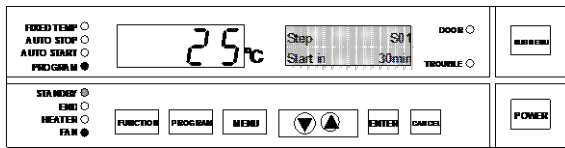

① Press the ENTER key to decide the operation start wait period/time. The unit enters to program operation wait state. The blinking PROGRAM lamp lights on and the STANDBY lamp blinks instead in this state. The fan rotates or stops according to the setting of "Fan (standby)". The Sub Display displays the step number and residual time to operation start.

② The operation starts when the residual time counts zero. The STANDBY lamp lights off and the Sub Display displays the executing step number and the setting temperature after the operation starts.

③ The following screens are displayed in sequence during operation.

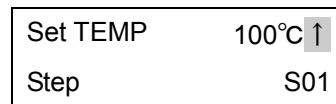

(Executing step number)

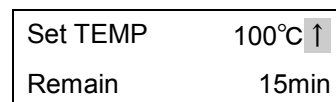

(Remaining time)

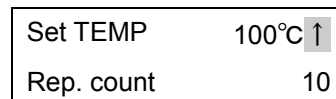

(Residual count of repeat:
displayed during repeat only)

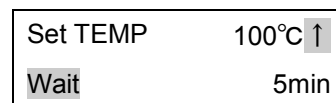

(Waiting state: displayed
during wait only)

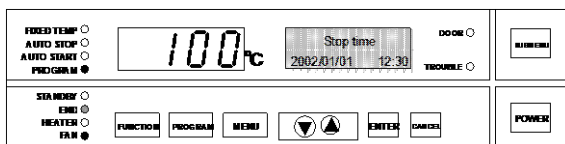

④ The END lamp blinks and the Sub Display displays the operation finish time when the operation stops.

⑤ Press the POWER key to cancel the operation or quit the wait state.

Input Program

1 Select program function

- Check that the power is turned on.

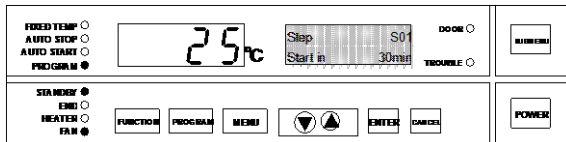

- ① Press the PROGRAM key. The program menu starts and step number selection screen is displayed.
Press the "▼▲". The registered step numbers and the smallest number of un-used step are displayed in sequence. Select the step number among them.
❖ The "S01" is displayed when no program is registered. In this case, the "▼▲" are invalid.
- ② Press the ENTER key. The selected step number is decided and the setting item selection screen is displayed. The "Set TEMP" is displayed first.
- ③ Press the CANCEL key to cancel the program menu.

2 Edit step

- After the step number is decided, the setting item selection screen is displayed. Select the items on the Sub Display using the PROGRAM key.

No.	Item	Sub Display	Notes
1	Setting temperature	Set TEMP 100°C S01	Settable value: 0 to 260°C (270°C maximum) Use with the temperature of 260°C or less regardless of the setting temperature range.
2	Setting time	Set time 0min S01	Settable value: 0 min to 59min, 1h00min to 999h59min, or "End"
3	Rotation speed of fan	Fan 10 S01	Settable value: 1 to 10, OFF
4	Repeat initiating step	Rep. start S01 S01	Input the step number of repeat initiating step or "No".
5	Repeat count	Rep. count 5 S01	Settable value: 1 to 9999, "Endless"
6	Step insertion	Insert step S01	Add a new step at the position of step currently referred to. The sequence number of each step hereafter increases by one.

Input Program

2	Edit step		
No.	Item	Sub Display	Notes
7	Step deletion	<div style="border: 1px solid black; padding: 2px; margin-bottom: 2px;">Delete step</div> S01	Delete the step currently referred to. The sequence number of each step hereafter decreases by one.
8	Program end	<div style="border: 1px solid black; padding: 2px; margin-bottom: 2px;">Program End</div> S01	Complete program registration/edition.

❖ The step number currently edited is displayed on the lower column of Sub Display. The details for all registered steps in use are displayed followed by all un-used steps.

❖ The "Set TEMP" for the next step follows the "Program End". The screen, in this way, displays the details of respective steps in sequence. The unused steps are displayed at the end if other steps are used. The display "un-used" is added at the end of step number displayed in the lower column of Sub Display for un-used steps. All steps subsequent to the step with "un-used" are un-used steps.

• The setting items are not displayed on the screen depending on the setting conditions shown below.

Setting item	Not displayed in the following condition
Setting temperature	Not displayed when the setting time is set to "End".
Setting time	Always displayed.
Rotation speed of fan	Always displayed.
Repeat initiating step	Not displayed when the period is set to "End" or when the other step is inserted in the specified repeat interval.
Repeat count	Not displayed when the repeat initiating step is not displayed, or "No" is set.
Step insertion	Not displayed when steps are left.

❖ It is impossible to change the content of program currently operated. Checking it is possible.

Input Program; Set the Temperature

1 Temperature setting procedure

- ① Select the "Set TEMP" and press the ENTER key. The temperature setting edition screen is displayed. The blinking " · " (cursor) goes out and the setting value blinks instead.

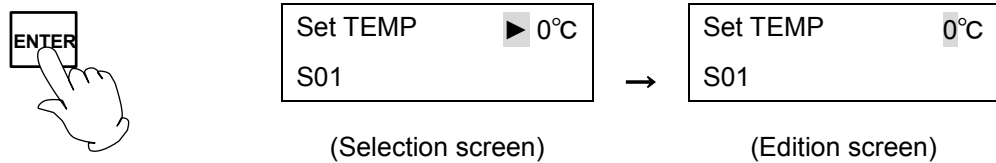

- ② Select the temperature using "▼▲" and press the ENTER key. The setting is decided and the screen returns to the setting item selection screen.

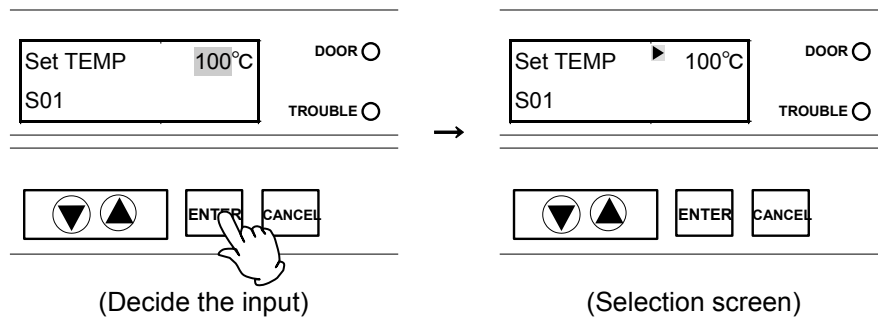

- ③ Press the CANCEL key to cancel the input. The value is cancelled and the screen returns to the setting item selection screen.

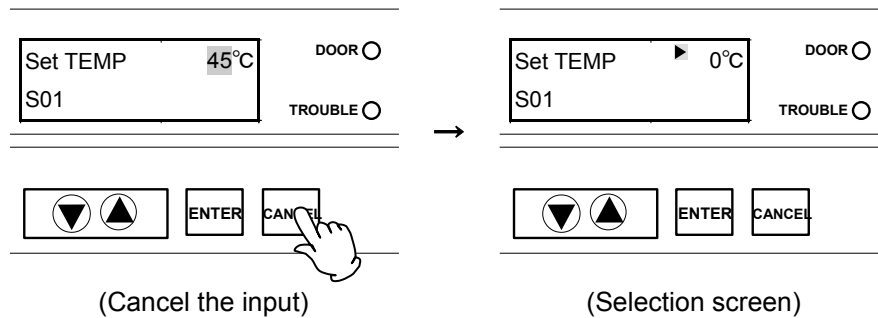

- ④ Press the PROGRAM key to display the next selection screen after the temperature setting is completed.

Input Program; Set the Time

1 Time setting procedure

- ① Select the "Set time" and press the ENTER key. The time setting edition screen is displayed. The blinking "·" (cursor) goes out and the setting value blinks instead.

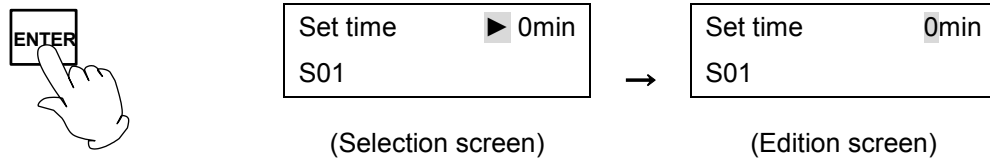

- ② Select the time using "▼▲" and press the ENTER key. The setting is decided and the screen returns to the setting item selection screen.

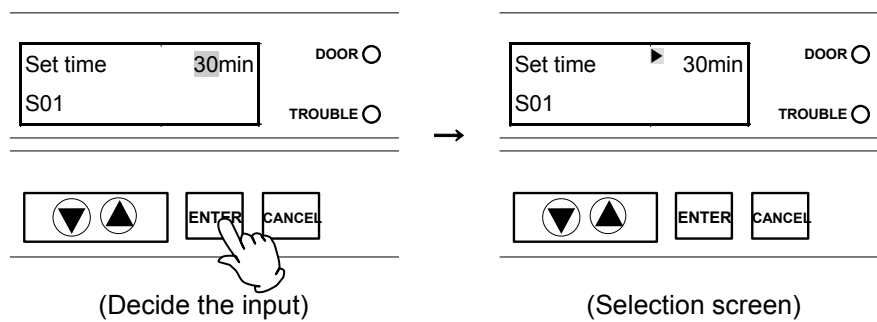

- ③ Press the CANCEL key to cancel the input. The value is cancelled and the screen returns to the setting item selection screen.

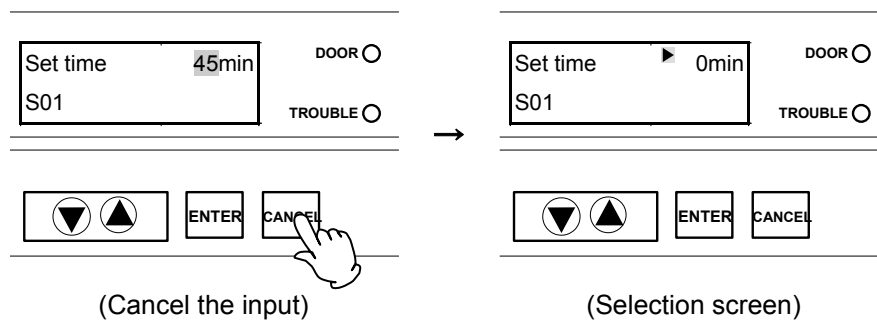

- ④ Press the PROGRAM key to display the next selection screen after the time setting is completed.

Input Program; Set the Fan Rotation Speed

1 Fan rotation speed setting procedure

- ① Select the "Fan" and press the ENTER key. The setting edition screen is displayed. The blinking "·" (cursor) goes out and the setting value blinks instead.

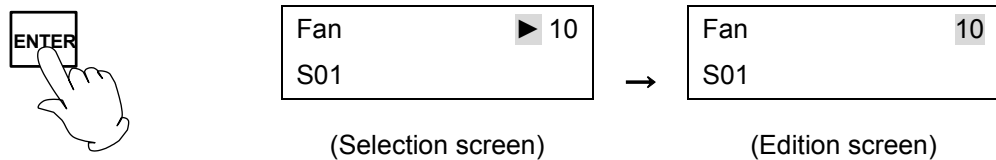

- ② Select the value using "▼▲" and press the ENTER key. The setting is decided and the screen returns to the setting item selection screen.

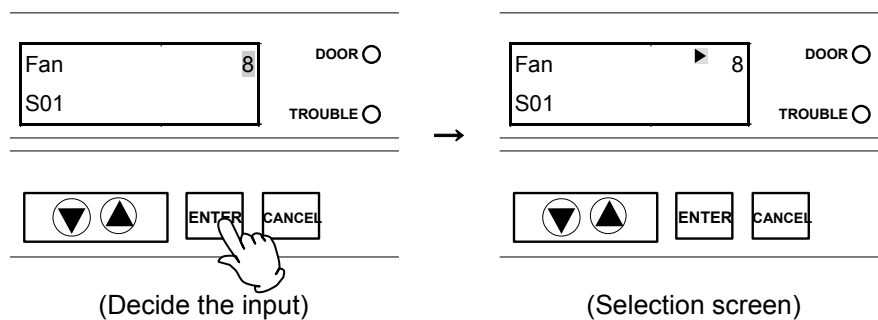

- ③ Press the CANCEL key to cancel the input. The value is cancelled and the screen returns to the setting item selection screen.

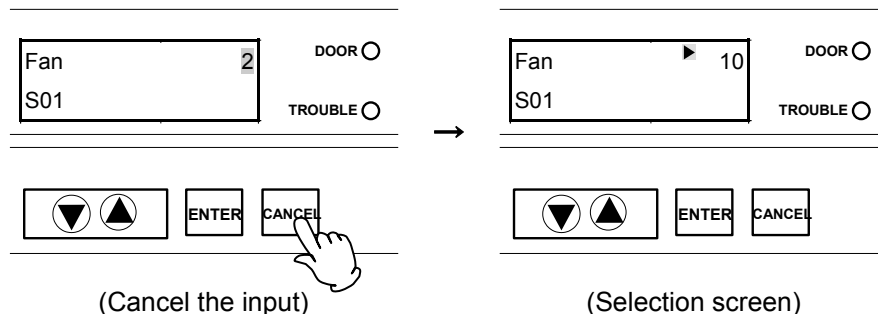

- ④ The fan stops at the same time of operation completion if "OFF" is selected at period setting of "End". The "OFF" can be selected only when the period is set to "End".
- ⑤ Press the PROGRAM key to display the next selection screen after the setting of fan rotation speed is completed.

Input Program; Set the Repeat Initiating Step

1 Repeat initiating step setting procedure

- ① Select the "Rep. start" and press the ENTER key. The setting edition screen is displayed. The blinking "·" (cursor) goes out and the setting value blinks instead.

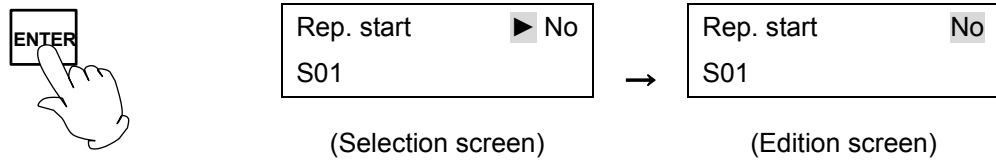

- ② Select the step number from which the repeat starts using the "▼▲", then press the ENTER key.

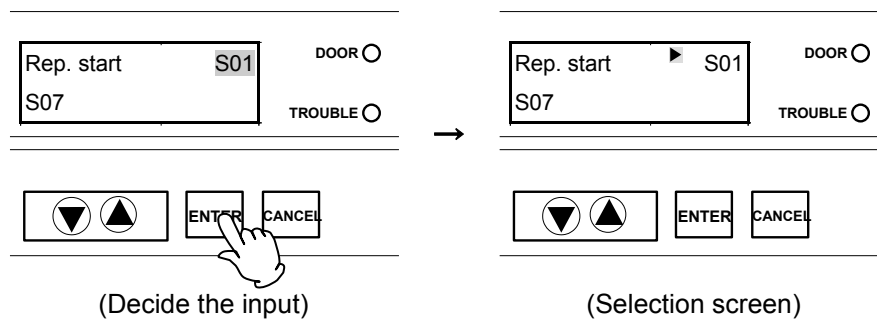

- ③ Press the CANCEL key to cancel the input. The value is cancelled and the screen returns to the setting item selection screen.

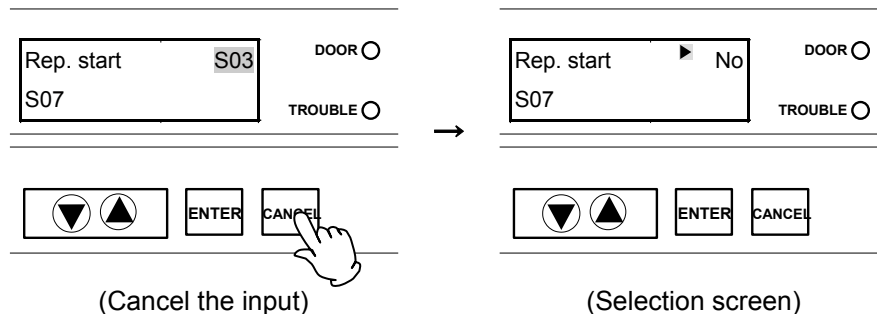

- ④ Press the PROGRAM key to display the next selection screen after the setting of repeat initiating step is completed.

Input Program; Set the Repeat Count

1 Repeat count setting procedure

- ① Select the "Rep. count" and press the ENTER key. The setting edition screen is displayed. The blinking "·" (cursor) goes out and the setting value blinks instead.

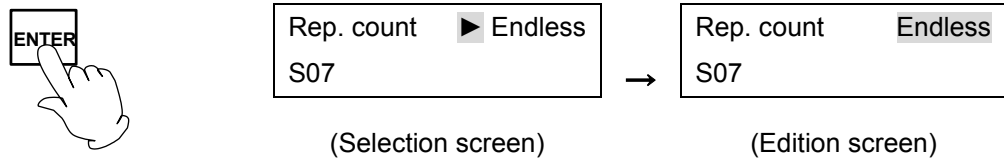

- ② Select the value using "▼▲" and press the ENTER key. The setting is decided and the screen returns to the setting item selection screen.

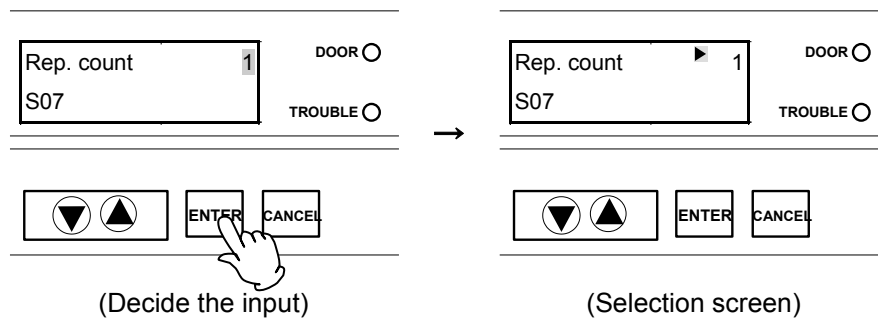

- ③ Press the CANCEL key to cancel the input. The value is cancelled and the screen returns to the setting item selection screen.

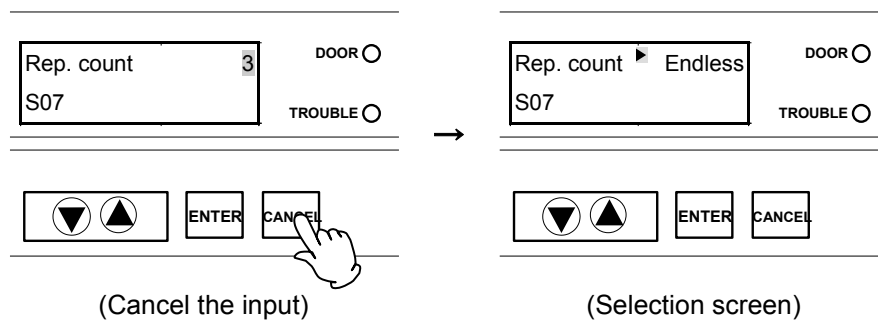

- ④ Press the PROGRAM key to display the next selection screen after the repeat count setting is completed.

Input Program; Insert Step

1 Step insertion procedure

- ① Select the "Insert step" and then press the ENTER key. A step is added there.

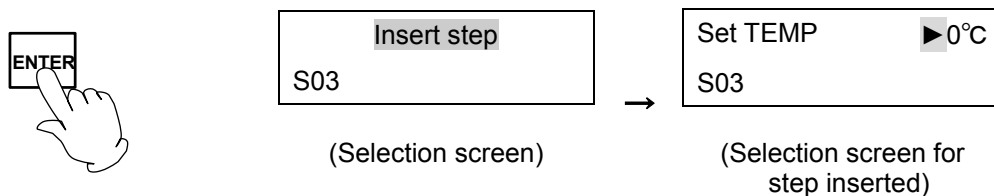

- ❖ The newly added step is inserted into the step number which is displayed on the selection screen. The sequence number of each registered step hereafter increases according to the number of steps added.
- ❖ The initial settings below are set in the newly inserted step. The settings of "un-used" steps displayed at the end of "Select step" are the same as that listed below.

Item	Initial setting
Setting temperature	0°C
Setting time	0 minute
Rotation speed of fan	10
Repeat initiating step	No

- ② Select the time using "▼▲" and press the ENTER key. The setting is decided and the screen returns to the setting item selection screen.
- ③ Press the PROGRAM key to display the next selection screen after the step insertion is completed.

Input Program; Add Step

1 Step addition procedure

- ① Display the setting of un-used step on the setting item selection screen and then press the ENTER key.

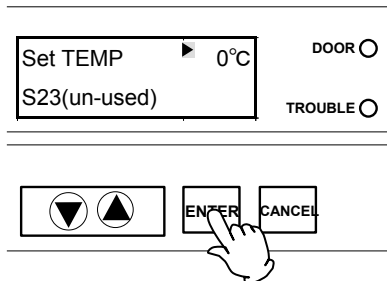

- ❖ The "SO1" (the first step) indicates "un-used" at the first registration of program.
- ❖ The items other than "Insert step", "Delete step" and "End program" can be set.
- ❖ The "un-used" steps are not displayed if no steps are left.

- ② Change the setting value and press the ENTER key.
 ③ The indication "un-used" on the lower column of Sub Display goes out.

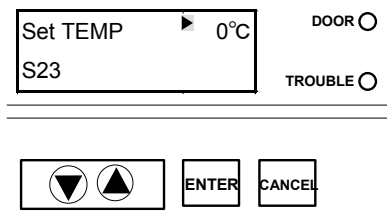

- ④ Set the other items respectively.
 ⑤ Press the PROGRAM key to display the next selection screen after step addition is completed.

Input Program; Delete Step

1 Step deletion procedure

- ① Press the program key. The program menu starts and step number selection screen is displayed. Press the "▼▲". The registered step numbers and the smallest number of un-used step are displayed in sequence. Select the step number to be deleted.

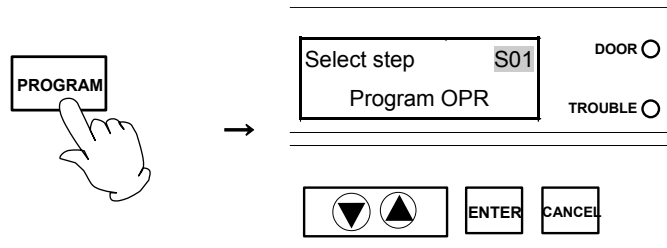

- ② Press the ENTER key.

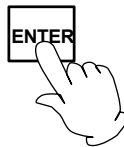

- ③ Press the PROGRAM key and select "Delete step".



- ④ Press the ENTER key. The selected step is deleted and the "Program End" screen is displayed.

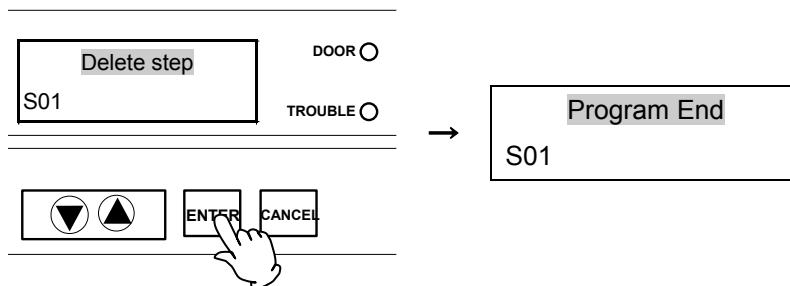

- ⑤ Press the ENTER key to end the program edition if the step to be deleted is correct.

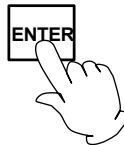

- ⑥ The unit enters into standby state where step deletion is completed.

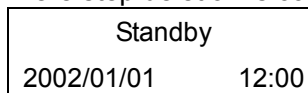

Input Program; End Program

1 End program procedure

- ① Select the "Program End" and press the ENTER key. The program edition is completed.

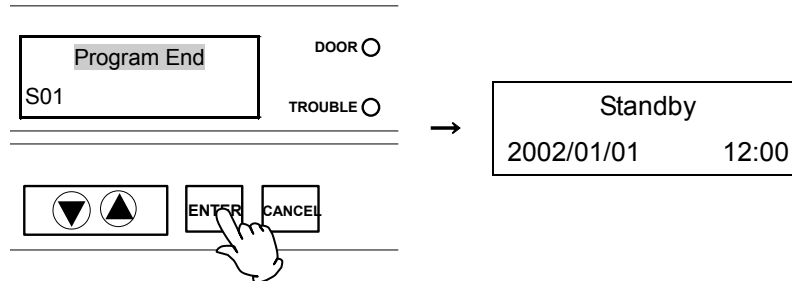

- ② The program edition has not done if the POWER or CANCEL key is pressed before pressing the "Program End" at the end of program edition.
- ③ Make sure to press the "Program End" after program edition.
The "Program End" can be set at any steps in addition to at the edition step.

Program Creation Method

The program pattern below is explained as an example.

- Program pattern example -

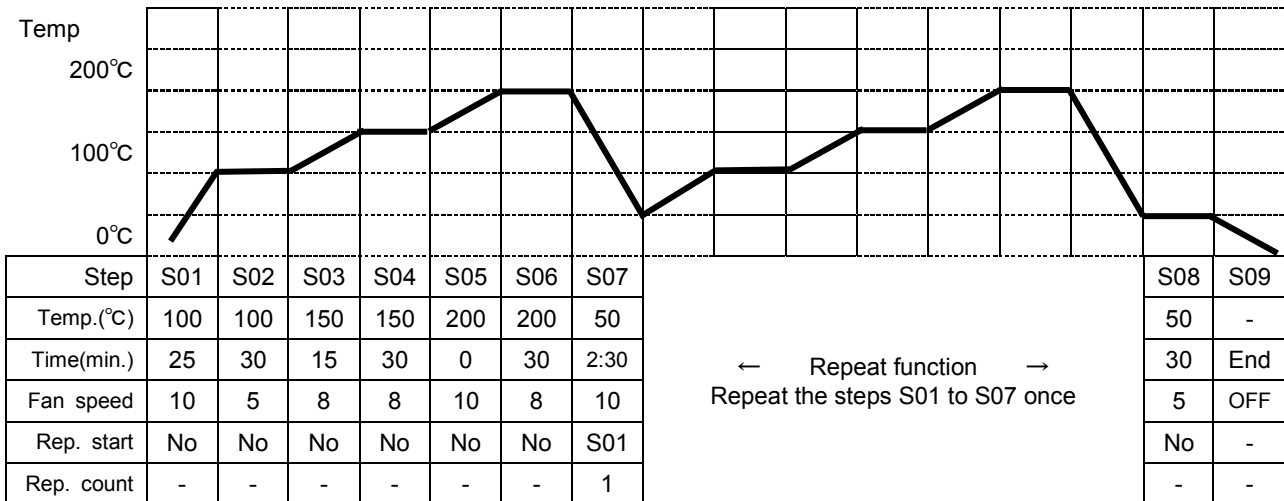

1 Select operation mode

- Check that the power is turned on.

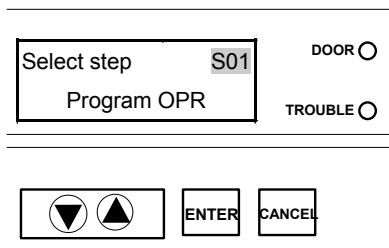

- ① Press the PROGRAM key. The program menu starts and step number selection screen is displayed.
Press the "▼▲". The registered step numbers and the smallest number of un-used step are displayed in sequence. Select the step number among them.
❖ The "S01" is displayed if no program is registered. In this case, the "▼▲" are invalid.
- ② Press the ENTER key. The selected step number is decided and the select the setting item selection screen is displayed. The "Set TEMP" is displayed at the beginning.
- ③ Press the CANCEL key to cancel the program menu.

Program Creation Method

1 Edit step

- The unit operates with fixed rate inclination if the "START TEMP" and the "Set Temp" are different. It enters into "Wait" if the temperature does not reach to the setting temperature within a setting time.

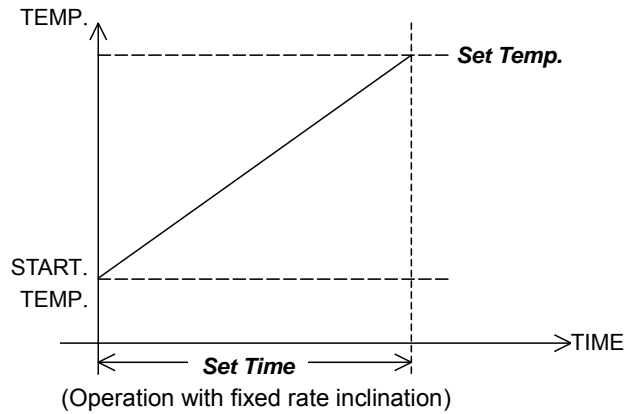

- The temperature is kept constant till the end of setting time when the "START TEMP" and the "Set Temp" are the same. The unit enters into "Wait" and measurement of residual time is suspended when the temperature in furnace is 6°C over or 3°C below to the setting temperature.

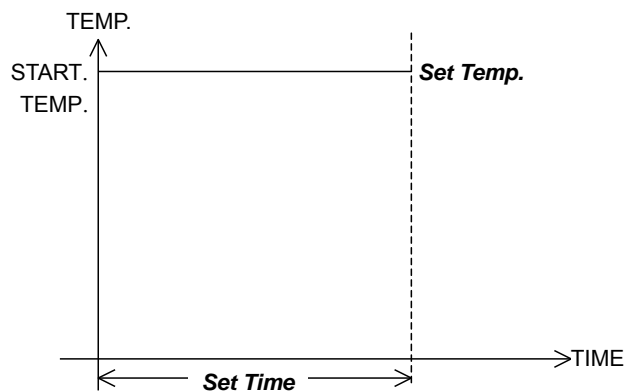

- The unit operates with full-power from the "START TEMP" to the "Set Temp". It keeps the "Wait" state until the temperature in furnace comes over 6°C or below 3°C to the setting temperature.

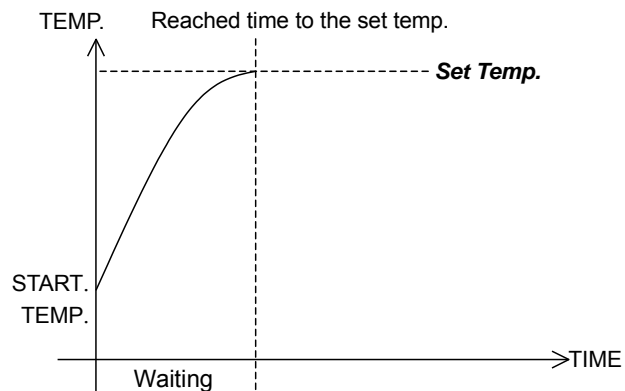

Program Creation Method

<p>1</p>	<p>Program creation; Step 1 (S01)</p> <div style="border: 1px solid black; padding: 5px; margin-bottom: 10px;"> Fan ▶ 10 S01 </div> <div style="border: 1px solid black; padding: 5px;"> Rep. start ▶ No S01 </div>	<p>⑥ Press the PROGRAM key. The fan rotation speed selection screen is displayed.</p> <p>⑦ Press the ENTER key. The fan rotation speed edition screen is displayed. Set "10" using the "▼▲" and press the ENTER key to decide it. (The next selection screen can be displayed by pressing the ENTER key when the setting value is indicated in the selection screen.)</p> <p>⑧ Press the PROGRAM key. The repeat initiating step selection screen is displayed.</p> <p>⑨ Press the ENTER key. The repeat initiating step edition screen is displayed. Set "No" using the "▼▲" and press the ENTER key to decide it.</p>
<p>2</p>	<p>Program creation; Step 2 (S02)</p> <hr/> <div style="border: 1px solid black; padding: 5px; display: inline-block;"> Set TEMP S02 S02(un-used) </div> <div style="margin-left: 20px;"> DOOR ○ TROUBLE ○ </div> <hr/> <div style="display: flex; justify-content: space-around; align-items: center;"> <div style="border: 1px solid black; padding: 2px;"> ▼ ▲ </div> <div style="border: 1px solid black; padding: 2px;"> ENTER </div> <div style="border: 1px solid black; padding: 2px;"> CANCEL </div> </div> <hr/> <div style="border: 1px solid black; padding: 5px; margin-bottom: 10px;"> Set TEMP ▶ 0°C S02 </div> <div style="border: 1px solid black; padding: 5px; margin-bottom: 10px;"> Set time ▶ 0min S02 </div> <div style="border: 1px solid black; padding: 5px;"> Fan ▶ 10 S02 </div>	<p>① Keep pressing the PROGRAM key until "SteP2" (S02) is displayed.</p> <div style="border: 1px solid black; padding: 5px; margin: 10px auto; width: fit-content;"> Set TEMP ▶ 0°C S02(un-used) </div> <p style="text-align: center;">↑ (Displayed only when nothing is input in Step 2)</p> <p>② Press the ENTER key. The setting temperature selection screen is displayed.</p> <p>③ Press the ENTER key. The setting temperature edition screen is displayed. Set "100°C" using the "▼▲" and press the ENTER key to decide it.</p> <p>④ Press the PROGRAM key. The setting period selection screen is displayed.</p> <p>⑤ Press the ENTER key. The setting period edition screen is displayed. Set "30min" using the "▼▲" and press the ENTER key to decide it.</p> <p>⑥ Press the PROGRAM key. The fan rotation speed selection screen is displayed.</p> <p>⑦ Press the ENTER key. The fan rotation speed edition screen is displayed. Set "5" using the "▼▲" and press the ENTER key to decide it.</p>

Program Creation Method

3 Program creation; Step 3 (S03) to Step 7 (S07)

Set TEMP ▶ 0°C
S03(un-used)

Set TEMP S07 DOOR ○
Program OPR TROUBLE ○

▼ ▲ ENTER CANCEL

Set TEMP ▶ 0°C
S07

Set time ▶ 0min
S07

Fan ▶ 0
S07

Rep. start ▶ No
S07

Rep. start S01
S07

Rep.count ▶ Endless
S07

- ① Keep pressing the PROGRAM key until "SteP 3" (S03) is displayed.
- ② Edit in the same way to Step 6 (S06) and then keep pressing the PROGRAM key until the Step 7 (S07) is displayed.
- ③ Press the ENTER key. The setting temperature selection screen is displayed.
- ④ Press the ENTER key. The setting temperature edition screen is displayed. Set "50°C" using the "▼▲" and press the ENTER key to decide it.
- ⑤ Press the PROGRAM key. The setting period selection screen is displayed.
- ⑥ Press the ENTER key. The setting period edition screen is displayed. Set "2h30min" using the "▼▲" and press the ENTER key to decide it.
- ⑦ Press the PROGRAM key. The fan rotation speed selection screen is displayed.
- ⑧ Press the ENTER key. The fan rotation speed edition screen is displayed. Set "10" using the "▼▲" and press the ENTER key to decide it.
- ⑨ Press the PROGRAM key. The repeat initiating step selection screen is displayed.
- ⑩ Press the ENTER key. The repeat initiating step edition screen is displayed. Set "S01" using the "▼▲" and press the ENTER key to decide it.
- ⑪ Press the PROGRAM key. The repeat count selection screen is displayed.
- ⑫ Press the ENTER key. The repeat count edition screen is displayed. Set "1" using the "▼▲" and press the ENTER key to decide it.

Program Creation Method

3 Program creation; Step 8 (S08) to Step 9 (S09)

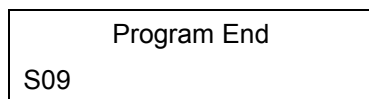
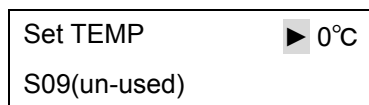
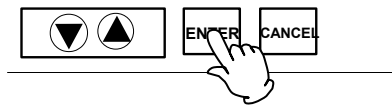
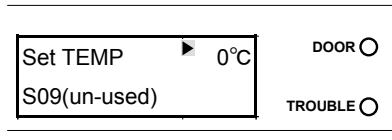

- ① Keep pressing the PROGRAM key until "SteP 8" (S08) is displayed.
- ② Edit in the same way for Step 8 (S08).
- ③ Keep pressing the PROGRAM key until "SteP 9" (S09) is displayed.
- ④ Press the ENTER key. The setting temperature selection screen is displayed.
- ⑤ Press the ENTER key. The setting temperature edition screen is displayed. Set "End" using the "▼▲" and press the ENTER key to decide it.
- ⑥ Press the PROGRAM key. The fan rotation speed selection screen is displayed.
- ⑦ Press the ENTER key. The fan rotation speed edition screen is displayed.
- ⑧ Keep pressing the PROGRAM key until "Program End" is displayed. Press the ENTER key to terminate the program setting.
- ⑨ The setting of program is completed by pressing the ENTER key. The unit enters into the standby state.

Set the Timer Mode

❖ Changes in timer mode are not reflected in the operation currently carried out in the following state of unit; operation start waiting state in the auto start mode, during auto stop mode operation, and operation start waiting state in the program operation mode. The changes are reflected on and after the next operation.

1 Select the item in function menu

- Check that the power is turned on.

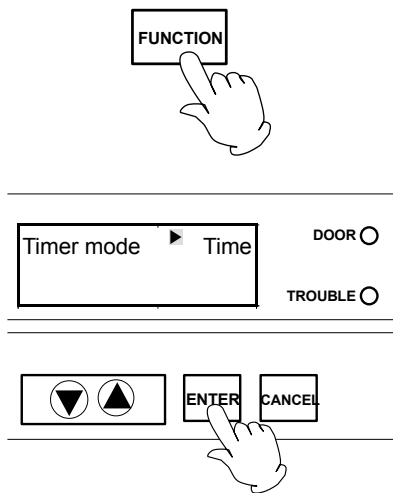

① Press the FUNCTION key. The function menu starts and the Sub Display displays the items. Select the item using the FUNCTION key.

② Display the "Timer mode" and press the ENTER key.

❖ Press the CANCEL key to cancel the function menu.

2 Select mode

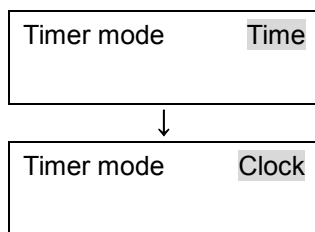

① The "·" (cursor) goes out and the mode currently selected blinks instead. Display the "Time" or "Clock" using the "▼▲".

3 Set timer mode

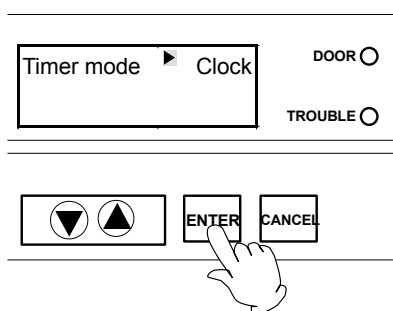

① Press the ENTER key. The timer mode is decided and the function menu selection screen is displayed.

Set the Key Lock Mode

1 Select the item in function menu

- Check that the power is turned on.

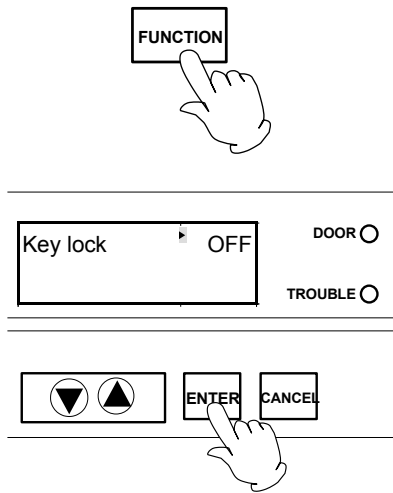

- ① Press the FUNCTION key. The function menu starts and the Sub Display displays the items. Select the item using the FUNCTION key.

- ② Display the "Key lock" and press the ENTER key.

2 Select mode

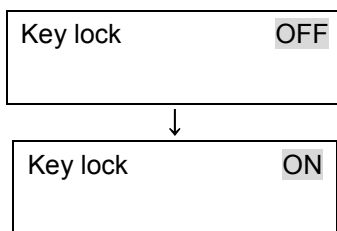

- ① The "·" (cursor) goes out and the mode currently selected blinks instead. Display the "ON" or "OFF" using the "▼▲".

3 Set key lock mode

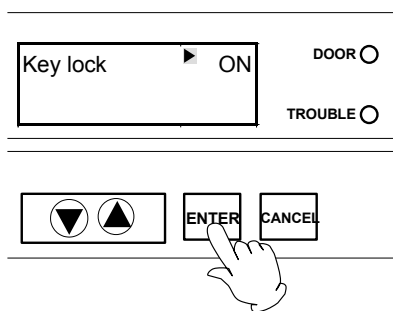

- ① Press the ENTER key. The key lock mode is decided and the function menu selection screen is displayed.

- ❖ Only the POWER key and change of key lock mode are available in key lock state. If any operation except that is done, the Sub Display displays the "Key lock" with the alarm sound.

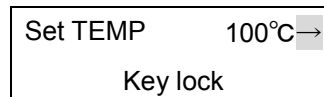

(Screen of the fixed temperature operation)

Set the Buzzer Mode

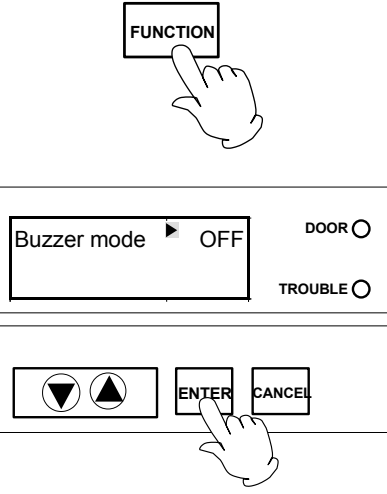
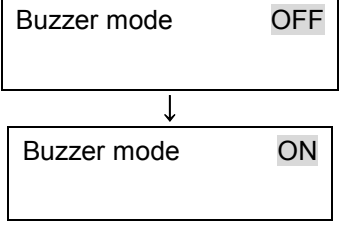
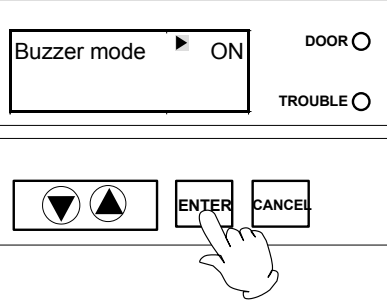
<p>1</p>	<p>Select the item in function menu</p> <ul style="list-style-type: none"> • Check that the power is turned on. 	<ol style="list-style-type: none"> ① Press the FUNCTION key. The function menu starts and the Sub Display displays the items. Select the item using the FUNCTION key. ② Display the "Buzzer mode" and press the ENTER key.
<p>2</p>	<p>Select mode</p> 	<ol style="list-style-type: none"> ① The "·" (cursor) goes out and the mode currently selected blinks instead. Display the "ON" or "OFF" using the "▼▲".
<p>3</p>	<p>Set buzzer mode</p> 	<ol style="list-style-type: none"> ① Press the ENTER key. The buzzer mode is decided and the function menu selection screen is displayed. <ul style="list-style-type: none"> ❖ The buzzer at auto stop and at the end of program operation does not sound when the buzzer mode is turned to "OFF". It sounds when the safety device works because a trouble occurs on the unit.

Calibration Offset Function

- ❖ Calibration offset is a function which corrects the difference between the temperature in furnace and that of controller (sensor temperature) if arises. The function parallel corrects the difference either to the plus or minus side within the whole temperature range of unit.

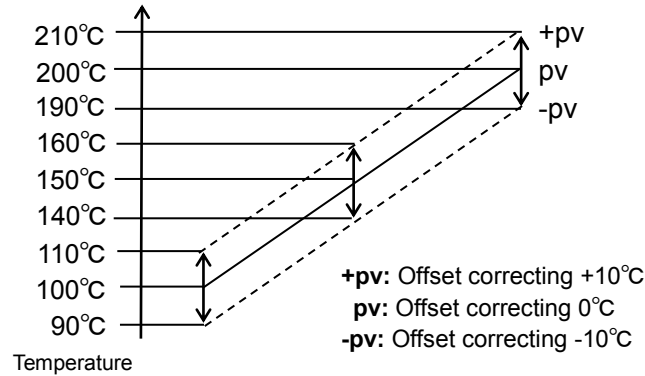

1 Select the item in function menu

- Check that the power is turned on.

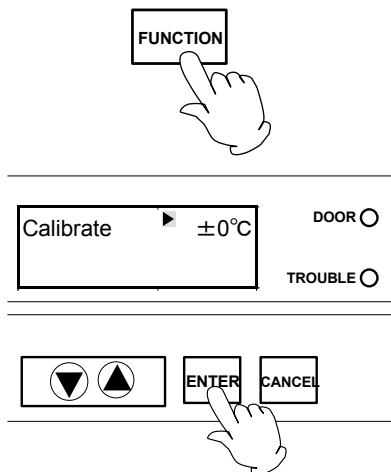

- ① Press the FUNCTION key. The function menu starts and the Sub Display displays the items. Select the item using the FUNCTION key.

- ② Display the "Calibrate" and press the ENTER key.

2 Input value

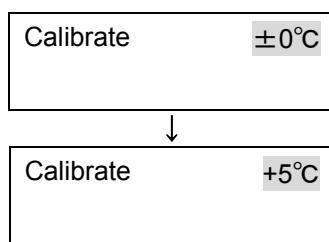

- ① The "·" (cursor) goes out and the current offset temperature blinks instead. Select the "-" to lower the temperature (to rise that in furnace), or "+" to rise it (to lower that in furnace) to display the offset temperature using the "▼▲".

3 Set calibration offset

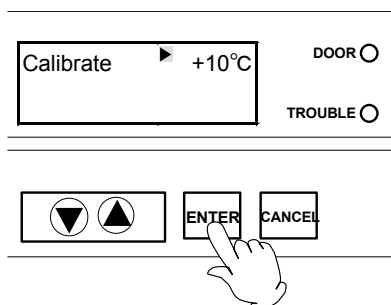

- ① Press the ENTER key. The setting is decided and the function menu selection screen is displayed.

- ❖ Offset is adjustable within the range from +13°C to -13°C.

Integrating Operation Time

❖ The integrating operation time is a function to check the operation hours of unit. Its content can not be changed.

1 Select the item in function menu

- Check that the power is turned on.

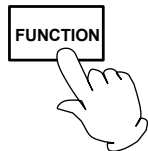

- ① Press the FUNCTION key. The function menu starts and the Sub Display displays the items. Select the item using the FUNCTION key.

2 Check integrating operation time

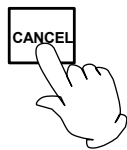
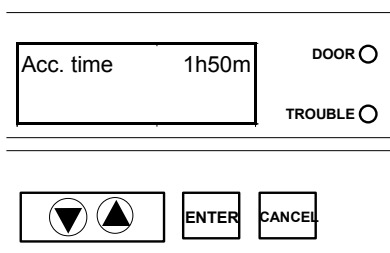

- ① The integrating operation time from factory shipment to now is displayed.

❖ The integrating operation time indicates the total sum of lapsed time in standby, operation start wait, operation and operation end state.

- ② Press the CANCEL key to cancel the function menu after checking the time.

Set Clock

- ❖ The clock is not set at factory shipment. Set it with your watch or time tone before using the unit.
- ❖ The setting for clock can not be changed at the operation start waiting state in the auto start mode/program mode, or during operation. Press the POWER key and stop operation to change it.

1 Select the item in function menu

- Check that the power is turned on.

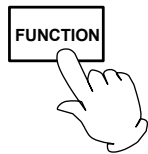

- ① Press the FUNCTION key. The function menu starts and the Sub Display displays the items. Select the item using the FUNCTION key.

2 Select the setting item

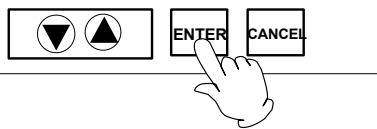
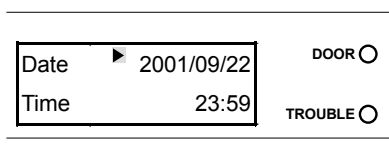

- ① Display the "Date" and "Time" using the FUNCTION key. The date and time currently set are displayed.

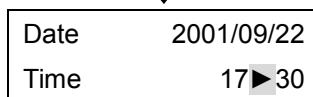
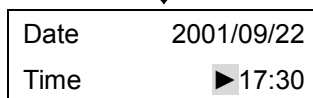
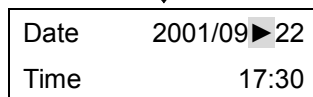
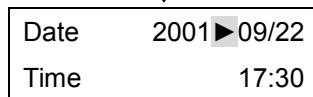

- ② The "·" (cursor) moves to "year", "month", "date", "hour" and "minute" in this order when the FUNCTION key is pressed. Select the item to be set and press the ENTER key.

Set Clock

3 Input value

Date	2001/09/22
Time	17:30

↓

Date	2002/09/22
Time	17:30

- ① The "·" (cursor) goes out and the current value blinks instead. Display the desired value using the "▼▲".

4 Set clock

Date	▶ 2002/09/22	DOOR ○
Time	23:59	TROUBLE ○

▼▲	ENTER	CANCEL
----	-------	--------



- ① Press the ENTER key. The setting is decided and the function menu selection screen is displayed.

Set Fan Operation at Wait State

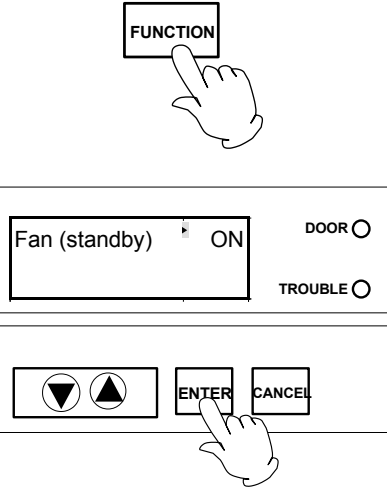
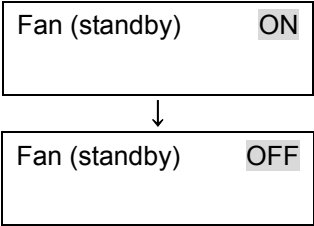
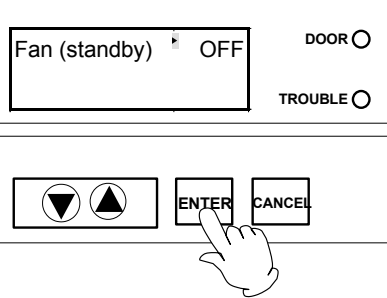
<p>1</p>	<p>Select the item in function menu</p> <ul style="list-style-type: none"> • Check that the power is turned on. 	<ol style="list-style-type: none"> ① Press the FUNCTION key. The function menu starts and the Sub Display displays the items. Select the item using the FUNCTION key. ② Display the "Fan (standby)" and press the ENTER key.
<p>2</p>	<p>Select mode</p> 	<ol style="list-style-type: none"> ① The "·" (cursor) goes out and the mode currently selected blinks instead. Display the "ON" or "OFF" using the "▼▲".
<p>3</p>	<p>Set fan operation</p> 	<ol style="list-style-type: none"> ① Press the ENTER key. The fan operation is decided and the function menu selection screen is displayed. <ul style="list-style-type: none"> ❖ The fan rotates during the standby state when the "Fan (standby)" is set to "ON". It does not rotate if set to "OFF". ❖ The rotation speed of fan depends on the setting value in "Fan speed".

Set the Fan Rotation Speed

- ❖ The setting value of fan rotation in each operation mode is displayed in the following three conditions. They, however, can not be changed.
 - Operation completed state in auto stop mode, and the fan function parameter is set to "OFF".
 - During operation or operation completed state in program operation mode.
 - Remote operation mode.

1 Select the item in function menu

- Check that the power is turned on.

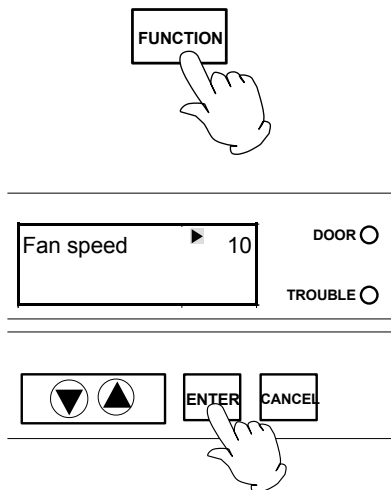

- ① Press the FUNCTION key. The function menu starts and the Sub Display displays the items. Select the item using the FUNCTION key.

- ② Display the "Fan speed" and press the ENTER key.

2 Input value

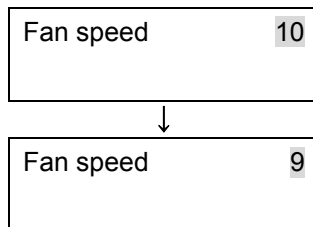

- ① The "·" (cursor) goes out and the mode currently selected blinks instead. Select the speed from "1" to "10" using the "▼▲" to display them. The fan rotates fastest when "10" is selected.

3 Set fan rotation speed

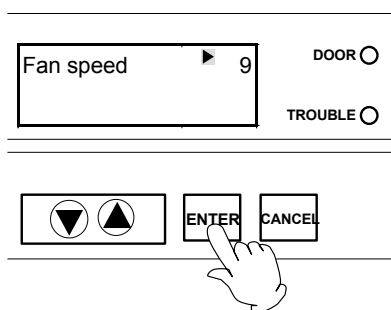

- ① Press the ENTER key. The setting is decided and the function menu selection screen is displayed.

Set the Communication Lockout Mode (Optional accessory)

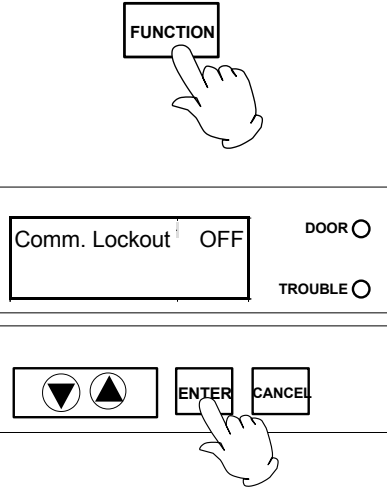
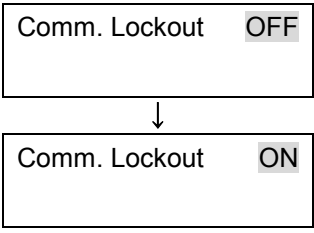
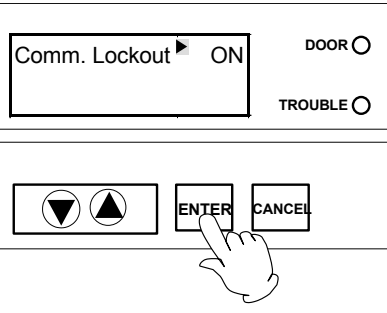
<p>1</p>	<p>Select the item in function menu</p> <ul style="list-style-type: none"> • Check that the power is turned on. 	<ol style="list-style-type: none"> ① Press the FUNCTION key. The function menu starts and the Sub Display displays the items. Select the item using the FUNCTION key. ② Display the "Comm. Lockout" and press the ENTER key.
<p>2</p>	<p>Select mode</p> 	<ol style="list-style-type: none"> ① The "·" (cursor) goes out and the mode currently selected blinks instead. Display the "ON" or "OFF" using the "▼▲".
<p>3</p>	<p>Set communication lockout mode</p> 	<ol style="list-style-type: none"> ① Press the ENTER key. The communication lockout mode is decided and the function menu selection screen is displayed.

How to Operate the Damper

1 Adjust the ventilation level by shifting the damper knob up or down.

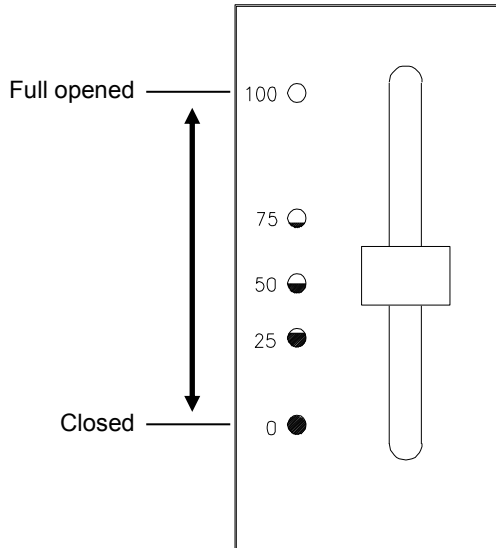

- Closing the damper reduces the temperature rising time and saves electricity.
We recommend setting the damper knob at 0 unless using for ventilation or shortening the time for the temperature to fall.
- When the damper is opened during operation under high temperature, hot air spouts out from the exhaust opening.
Be sure to make enough space between the back surface and the wall. (Refer to page 4 "2. Choose a proper place for installation")
- The exhaust opening and surrounding surface becomes very hot.
Take care not to get burned.
- Opening the damper too much may prevent the temperature from reaching the desired level due to over-ventilation.

The Independent Overheating Prevention Device

1 Select the item in function menu

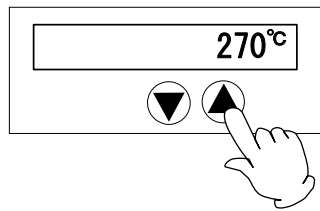

① Set the temperature using the "▼▲".

Notes for the independent overheating prevention device



- In case there is a small difference between the set values of temperature for the independent overheating prevention device and that of controller, the independent overheating prevention device may be activated and stops the operation. Set the temperature of the device so it be at least 10°C or more higher than that of controller.
- The default value of the independent overheating prevention device at factory shipment is 270°C.
- The independent overheating prevention device is not intended to protect the sample from overheating.
- For the independent overheating prevention device to start at the required temperature, first establish a stable operation at such a required temperature, and lower gradually the setting value of the independent overheating prevention device, and then check if the operation is maintained with stable at the required temperature. (It takes about five seconds for the device to activate. Check after waiting for five seconds.) When the device activates, the unit indicates Er07 and stops the operation.
- Wait for about five seconds for the period to record it before turning off the power after the setting temperature of independent overheating prevention device is changed.

Temperature Rise/Fall Data (Reference Data)

The temperature rise/fall data show the reference value when the unit is operated without load. The program should be created based on the data collected by operating the unit with samples put there.

Temperature rise data

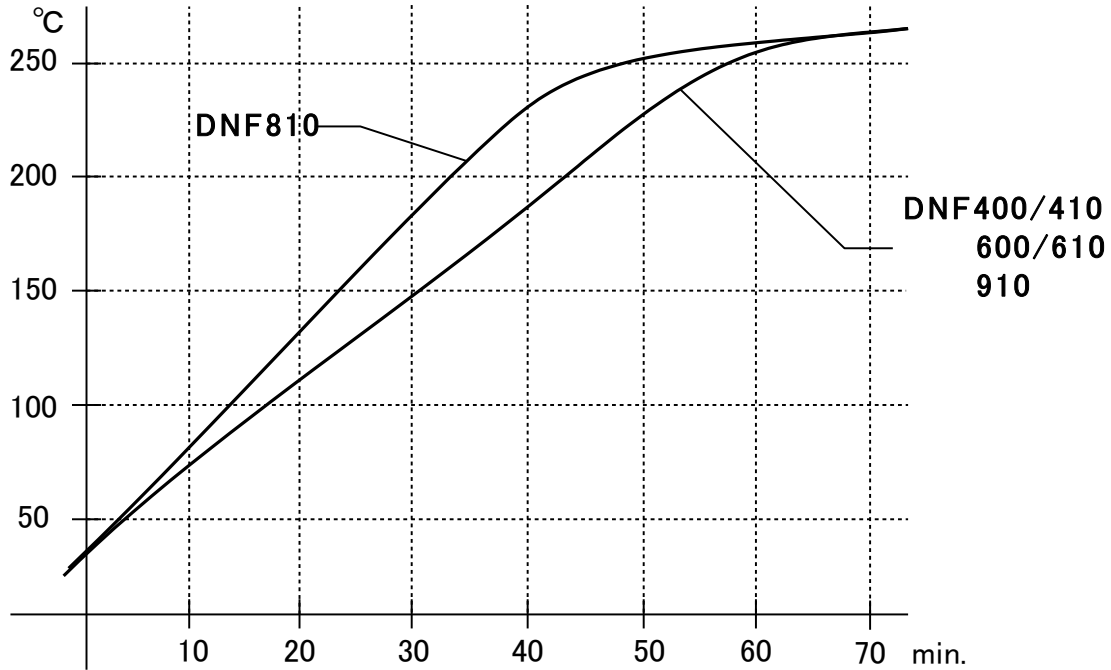

Temperature fall data

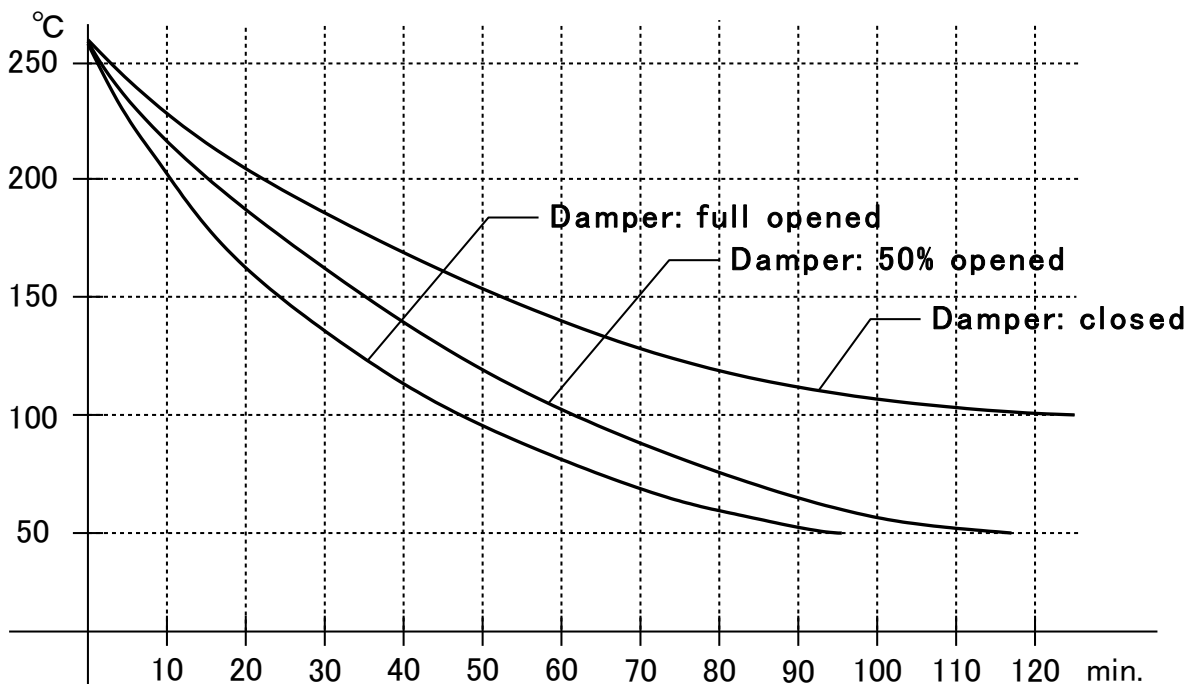

WARNING!

If a problem occurs

-  If smoke or strange odor should come out of this unit for some reason, turn off the power key right away, and then turn off the circuit breaker and the main power. Immediately contact a service technician for inspection. If this procedure is not followed, fire or electrical shock may result. Never perform repair work yourself, since it is dangerous and not recommended.

Substances that cannot be used

-  Never use explosive substances, flammable substances and substances that include explosive or flammable ingredients in this unit. Explosion or fire may occur. (Refer to page 71 "List of Dangerous Substances".)

CAUTION!

Do not step on this unit

-  Do not step on this unit. It will cause injury if this unit fall down or break.

Do not put anything on this unit

-  Keep clear on the unit to prevent dropping and injury. Do not put flammable such as paper around it.

During a thunder storm

-  During a thunderstorm, turn off the power key immediately, then turn off the circuit breaker and the main power. If this procedure is not followed, fire or electrical shock may be caused.

About the amount of samples

-  If the excessive amount of sample is set, it could be impossible to control the temperature normally. To keep the temperature control accuracy, do not use this unit in overload.

Exhaust and intake opening

-  The temperature in furnace may not reach to the operating temperature when the unit is used with its exhaust opening or air intake opening opened. In this case, close them as possible.

Recovering after power failure

-  When power is supplied after a power failure, the device automatically starts operation again with the same state as just before the power failure. It is danger that the device starts unattached operation after a power failure. We recommend for you to turn off the switch of this unit if a power failure occurs during operation.

Daily Inspection and Maintenance

WARNING!

- Disconnect the power cable from the power source when doing an inspection or maintenance unless needed.
- Perform the daily inspection and maintenance after returning the temperature of this unit to the normal one.
- Do not disassemble this unit.

CAUTION!

- Use a well-drained soft cloth to wipe dirt on this unit. Do not use benzene, thinner or cleanser for wiping. Do not scrub this unit. Deformation, deterioration or color change may result in.

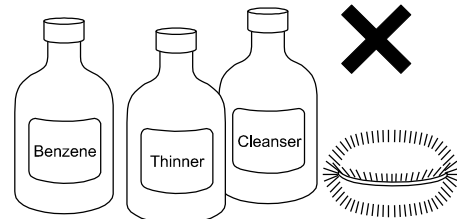

Monthly maintenance

- Check the earth leakage breaker function.
 1. Connect the power cord.
 2. Turn the breaker on.
 3. Push the red test switch by a ballpoint pen etc.
 4. If there is no problem, the earth leakage breaker will be turned off.

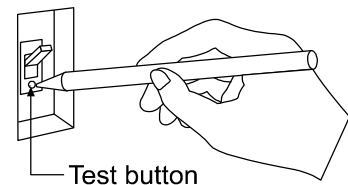

- Check the movement of the independent overheating prevention device.

Perform the fixed temperature operation of device with certain preset temperature. Then set the operation temperature of independent overheating prevention device to the value approximately 5°C lower than the preset temperature of device.

In normal condition, the device shuts off the heating circuit in a few seconds, at the same time the TROUBLE lamp lights on and the "Er07" is indicated accompanied with a warning buzzer.

- ❖ Be sure to check the movement of earth leakage breaker malfunction and overheating prevention device mentioned above before a long-term continuous operation or unmanned night operation.

For any questions, contact the dealer who you purchased this unit from, or the nearest sales division in our company.

When not using this unit for long term / When disposing

CAUTION!

When not using this unit for long term...

- Turn off the power and disconnect the power cord.

WARNING!

When disposing...

- Keep out of reach of children.
- Remove the door and driving parts.
- Treat as large trash.





Environmental protection should be considered

We request you to disassemble this unit as possible and recycle the reusable parts considering to the environmental protection. The feature components of this unit and materials used are listed below.



Component Name	Material
Main Parts	
Outer covering	Electrical zinc plated steel plate, Epoxy and melamine resin coating
Furnace	Stainless steel SUS304
Heat insulation material	Glass wool
Door packing	Silicon rubber
Door handle	Die casting aluminum, Epoxy and melamine resin coating
Plates	PET resin film
Electrical Parts	
Switches, Relay	Resin, Copper and other
Control panel	ABS resin
Circuit boards¥	Glass fiber and other
Heater	Stainless steel and other
Power cord	Synthetic rubber coating, Copper, Nickel and other
Wiring material	Glass fiber, Incombustible vinyl, Copper, Nickel and other
Sensor	Stainless steel SUS304 and other

Safety Device and Error Code

This unit has an automatic diagnosis function built in the controller and safety devices independent of the controller. The following table shows the purpose, operation and corrective actions against error of safety devices. If an error occurs, the Main Display indicates the error code and the Sub Display displays the error details/corrective actions with the buzzer sound. Correct the error according to the instruction.

Safety Device	Purpose	State	Display	Cause/Solution
Earth leakage breaker	To prevent electric shock, To protect over current	<ul style="list-style-type: none"> Power shut off All indications goes out 	None	<ul style="list-style-type: none"> ❖ Check the cause by contacting to our service division.
Sensor trouble detection	To prevent overheating due to sensor failure	<ul style="list-style-type: none"> Heater circuit shut off Alarm buzzer activated 	TROUBLE lamp blinks  <div style="border: 1px solid black; padding: 2px; width: fit-content; margin: 0 auto;">Sensor Error Call a service</div>	<ul style="list-style-type: none"> Temperature sensor is broken or disconnected. ❖ Check the cause by contacting to our service division.
Triac short-circuit detection	To prevent overheating due to impossibility of heater control	<ul style="list-style-type: none"> Heater circuit shut off Alarm buzzer activated 	TROUBLE lamp blinks  <div style="border: 1px solid black; padding: 2px; width: fit-content; margin: 0 auto;">SSR Error Call a service</div>	<ul style="list-style-type: none"> Triac is in short-circuit ❖ Check the cause by contacting to our service division.
Heater disconnecting detection	To notice failure in temperature control	<ul style="list-style-type: none"> Heater circuit shut off Alarm buzzer activated 	TROUBLE lamp blinks  <div style="border: 1px solid black; padding: 2px; width: fit-content; margin: 0 auto;">SSR Error Call a service</div>	<ul style="list-style-type: none"> Heater is disconnected. ❖ Check the cause by contacting to our service division.
Independent overheating prevention device	To prevent overheating due to controller failure	<ul style="list-style-type: none"> Heater circuit shut off Alarm buzzer activated 	TROUBLE lamp blinks  <div style="border: 1px solid black; padding: 2px; width: fit-content; margin: 0 auto;">Overheat Error Call a service</div>	<ul style="list-style-type: none"> False setting of the independent overheating prevention device. ❖ Set the device correctly. Overheating of sample. ❖ Reduce the sample. Sensor of the independent overheating prevention device is disconnected, or failure in the independent overheating prevention circuit. ❖ Check the cause by contacting to our service division.

Safety Device and Error Code

Safety Device	Purpose	State	Display	Cause/Solution
Main relay trouble detection	To notice impossibility of heater circuit shut off	<ul style="list-style-type: none"> Alarm buzzer activated 	TROUBLE lamp blinks  Main relay Er Call a service	<ul style="list-style-type: none"> Failure in main relay. ❖ Check the cause by contacting to our service division.
POST function (*)	To check operation of controller	<ul style="list-style-type: none"> Heater circuit shut off Alarm buzzer activated 	TROUBLE lamp blinks  or  Controller Er Call a service	<ul style="list-style-type: none"> ❖ Check the cause by contacting to our service division.
Automatic overheating prevention	To prevent overheating	<ul style="list-style-type: none"> Heater circuit shut off 	None	<ul style="list-style-type: none"> Overheating of sample. ❖ Reduce the sample.
Key lock	To prevent wrong operation	<ul style="list-style-type: none"> Only the POWER key and change of key lock mode are available in key lock state. 	The Sub Display displays the "Key lock" with the alarm sound if any of keys other than given left is pressed.	<ul style="list-style-type: none"> Set the function during operation to prevent the interruption of operation due to wrong operation. Refer to the page 44 for the setting/cancellation of function.

- The POST (Power On Self Test) function checks the microprocessor, memory, peripheral LSI and peripheral circuit every time the POWER key is turned on. The function also checks the existence of fatal failure before starting operation.

NOTE) Be sure to shut off the earth leakage breaker if any of safety devices above is activated. The protection circuit is released and the unit recovers by turning on the power after correcting the error if the safety device is activated due to overheating of sample or wrong operation.

Trouble Shooting

Refer to page 59 "Safety Device and Error Code" for the state of unit at activation of safety device and corrective actions.

Problem	Possible Cause	Solution
The sub indicator does not indicate current date and time when the electric leakage breaker is turned on.	Power is not supplied.	Check power connection and turn on electricity.
	Earth leakage breaker failure.	Replace the breaker (*)
	Controller failure.	Replace the controller (*)
The operation panel indicates none when the power key is pressed.	Problem in power source.	Connect to the appropriate power source.
	Controller failure.	Replace the controller (*)
Temperature does not rise.	Damper is opened.	Close the damper.
	The safety device in independent overheating prevention device or self-diagnosis function is activated and the heater circuit is shut off (error code indication).	Refer to page 59 "Safety Device and Error Code".
Temperature is slow in rising	Damper is opened.	Close the damper.
	Too much samples loaded.	Refer to the item 6 and 7 on page 6.
	Controller failure.	Replace the controller. (*)
	Temperature sensor failure.	Replace the sensor (*).
Instable indication of temperature	Variable ambient temperature.	Refer to the item 2 on page 4.
	Effect of sample.	Refer to the item 6 and 7 on page 6.
	Controller failure.	Replace the controller. (*)
	Temperature sensor failure.	Replace the sensor (*).

- Please consult your retailer or any of our branch offices for the corrective actions with "*" mark or that other than listed above.

If power failure occurs...

The unit returns automatically to start operation automatically with the same condition as just before the failure when it occurs during operation and is recovered. It, however, is dangerous that the unit starts unmanned operation automatically. We recommend to turn off the switch at power failure

In Case of Request for Repair

If the failure occurs, stop the operation, turn OFF the power switch, and unplug the power plug. Please contact the sales agency that this unit was purchased, or the Yamato Scientific's sales office.

< Check following items before contact >

- ◆ Model Name of Product
 - ◆ Production Number
 - ◆ Purchase Date
 - ◆ About Trouble (in detail as possible)
- } See the production plate attached to this unit.

Minimum Retention Period of Performance Parts for Repair

The minimum retention period of performance parts for repair of this unit is 7 years after discontinuance of this unit.

The "performance part for repair" is the part that is required to maintain this unit.

Specification

	DNF400/410	DNF600/610	DNF810	DNF910
Method	Wind velocity adjustable / Forced circulation (with exhaust damper)			
Temperature control range	Room temp.+ 5°C to 260°C			
Temperature adjustment accuracy	±0.5°C (at 260°C)			
Temperature distribution accuracy	±2.5°C (at 260°C)			
Time required to reach highest temperature	Approx. 75min.		Approx. 60min.	Approx. 75min.
Interior	Stainless steel plate (SUS304)			
Exterior	Electrical zinc plated steel plate, Epoxy and melamine resin coating			
Heat insulation material	Glass wool			
Heater	Stainless pipe heater			
	1.25kw	1.5kw	1.35kw × 2	1.65kw × 2
Fan/motor of blower	Sirocco fan/DC brushless motor (10 steps)			
	10W			10W × 2
Wind velocity adjusting system	10 steps			
Damper	Sliding knob on the front of the unit.			
Cable port	Inner diameter: 30mm (right surface of the unit)			
Exhaust opening	Inner diameter: 50mm (back surface of the unit)		Inner diameter: 50mm × 2 (back surface of the unit)	
Intake opening	Inner diameter: 30mm (right surface of the unit)			
Temperature control system	PID control by micro computer (VI CR3 type)			
Temperature setting system	Digital setting by up/down keys			
Temperature display system	Digital display by orange LED			
Other indications	Fluorescent character display of function			
Timer display range	0min to 99h59min, 100 to 999.5h			
Operation mode	Fixed temperature operation, Auto start operation, Auto stop operation, Program operation (max. of 32 steps, repeat operation)			
Additional functions	Timer, Clock, Total operating hours counter (max. of 49999h), Fan, Calibration offset			
Temperature sensor	K-thermocouple for the temperature control device and the overheating prevention device			
Safety device	Earth leakage breaker, Independent overheating prevention device, Key lock function, Self-diagnostic functions (Sensor error, Heater disconnection, Triac short circuit, Automatic overheating prevention)			
Internal dimensions (W × D × H mm)	450 × 450 × 450	600 × 500 × 500	600 × 500 × 1000	1090 × 500 × 1000
External dimensions (W × D × H mm)	580 × 646 × 860	730 × 696 × 910	730 × 696 × 1675	1220 × 696 × 1675

❖ The performance shown here is the value under the condition of the ambient temperature of 23°C±5°C, humidity of 65%RH±20%, intake and exhaust openings are closed, cable port is closed, fan rotation is set to maximum, and without load.

❖ The projection is not included for "Internal dimensions" and "External dimensions".

	DNF400/410	DNF600/610	DNF810	DNF910
Capacity	90L	150L	300L	540L
Withstand load of shelf	15kg/one shelf			
Number of shelf bracket step	11	13	29	
Interval of shelf bracket steps	30mm			
Power supply (50/60Hz)	DNF400: 115V AC, 11.5A DNF410: 220V AC, 6A single phase	DNF600: 115V AC, 13.5A DNF610: 220V AC, 7A single phase	220V AC, 13A single phase	220V AC, 15.5A single phase
Weight	Approx. 61Kg	Approx. 77Kg	Approx. 113Kg	Approx. 180Kg
Accessories	Shelf (stainless punching metal) × 2		× 4	× 8
	Shelf bracket × 4		× 8	× 16
	Instruction manual			

Optional Accessories

No.	Name	Product code
1	ON stand ON62 (for 400/410/600/610)	211187
2	OT stand OT42 (for 400/410)	212348
3	OT stand OT62 (for 600/610)	212349
4	Fitting for stacking ODN26 (for 400/410)	212806
5	Fitting for stacking ODN28 (for 600/610)	212807
6	Shelf (with bracket fitting) ODN20 (for 400/410)	212246
7	Shelf (with bracket fitting) ODN22 (for 600/610/810)	212266
8	Shelf (with bracket fitting) ODN24 (for 910)	212371
9	Cable port ϕ 25 ODN32	200000
10	Cable port ϕ 50 ODN34	200000
11	Right hinged type door ODN42 (for 400/410)	200000
12	Right hinged type door ODN44 (for 600/610)	200000
13	Right hinged type door ODN46 (for 810)	200000
14	External communication function (RS485)	200000
15	External communication adapter (RC23 conversion) ODN52	200000
16	Temperature output terminal (4 to 20Ma) ODN54	200000
17	Alarm output terminal ODN56	200000
18	Time up signal output terminal ODN58	200000
19	Output terminal for independent alarm unit (four point output)	200000
20	Terminal for sample temperature monitoring (three sensor mounting ports, three terminals maximum on the left face inside)	200000
21	Sensor for sample temperature monitoring (K thermocouple)	200000
22	Hybrid recorder (external installation) ODN62	200000

- Specify items 9 to 22 at order.

DNF400/600

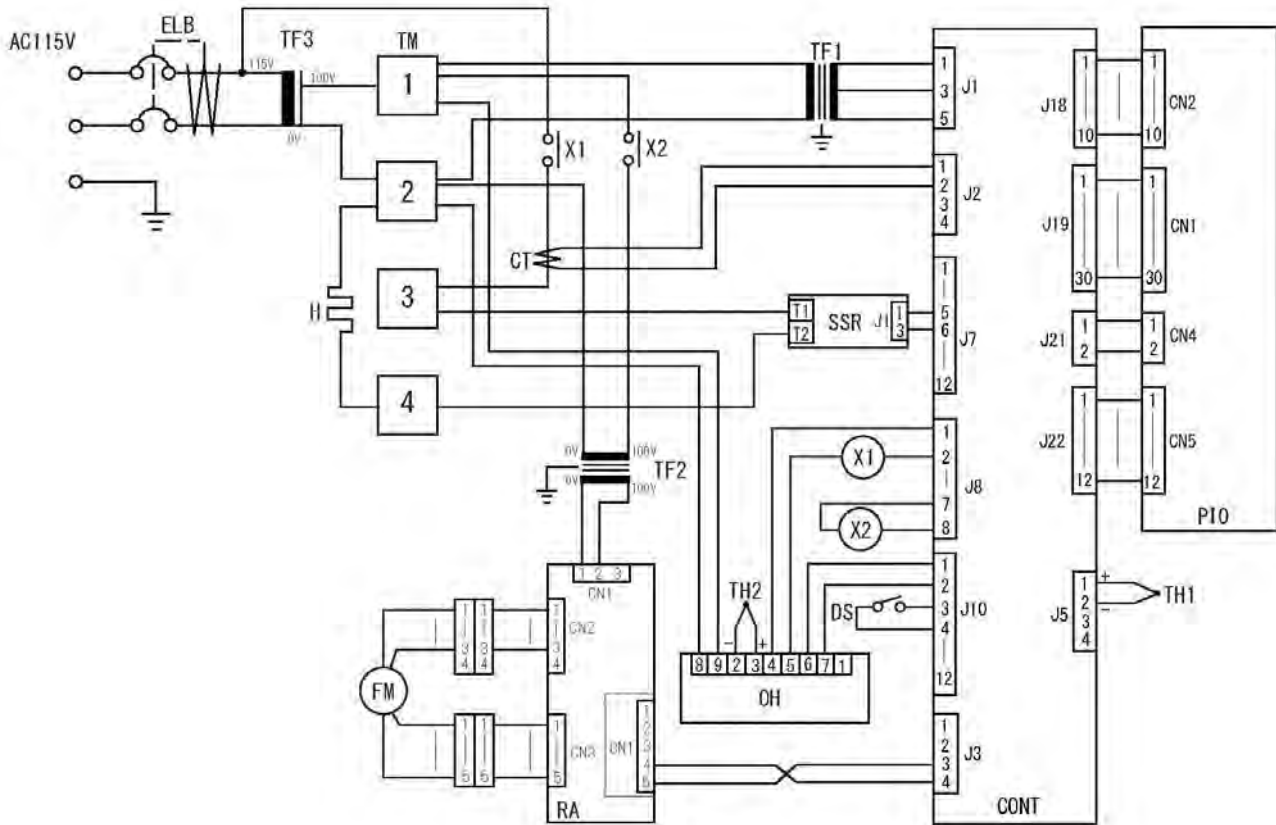

Symbol	Part name	Symbol	Part name
ELB	Earth leakage breaker	SSR	Triac
FM	Fan motor	OH	Independent overheating prevention device
H	Heater	CT	Current transformer
TM	Terminal block	TH1/TH2	Temperature sensor (K thermocouple)
TF1/2/3	Transformer	CONT	PLANAR board
X1	Relay (heater)	PIO	Display circuit board
X2	Relay (fan)	DC/RA	Fan controller
DS	Door switch	TF	Transformer

DNF410/610

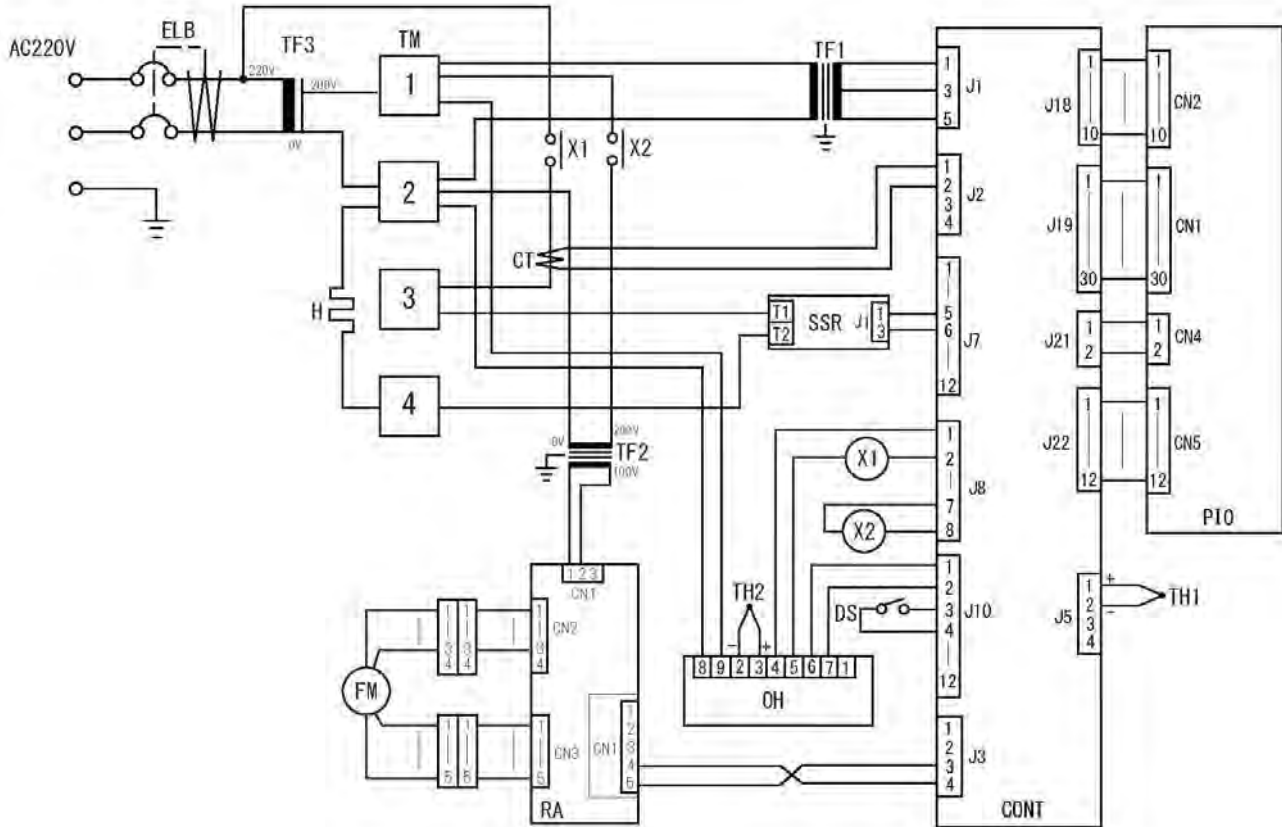

Symbol	Part name	Symbol	Part name
ELB	Earth leakage breaker	SSR	Triac
FM	Fan motor	OH	Independent overheating prevention device
H	Heater	CT	Current transformer
TM	Terminal block	TH1/TH2	Temperature sensor (K thermocouple)
TF1/2/3	Transformer	CONT	PLANAR board
X1	Relay (heater)	PIO	Display circuit board
X2	Relay (fan)	DC/RA	Fan controller
DS	Door switch	TF	Transformer

DNF810

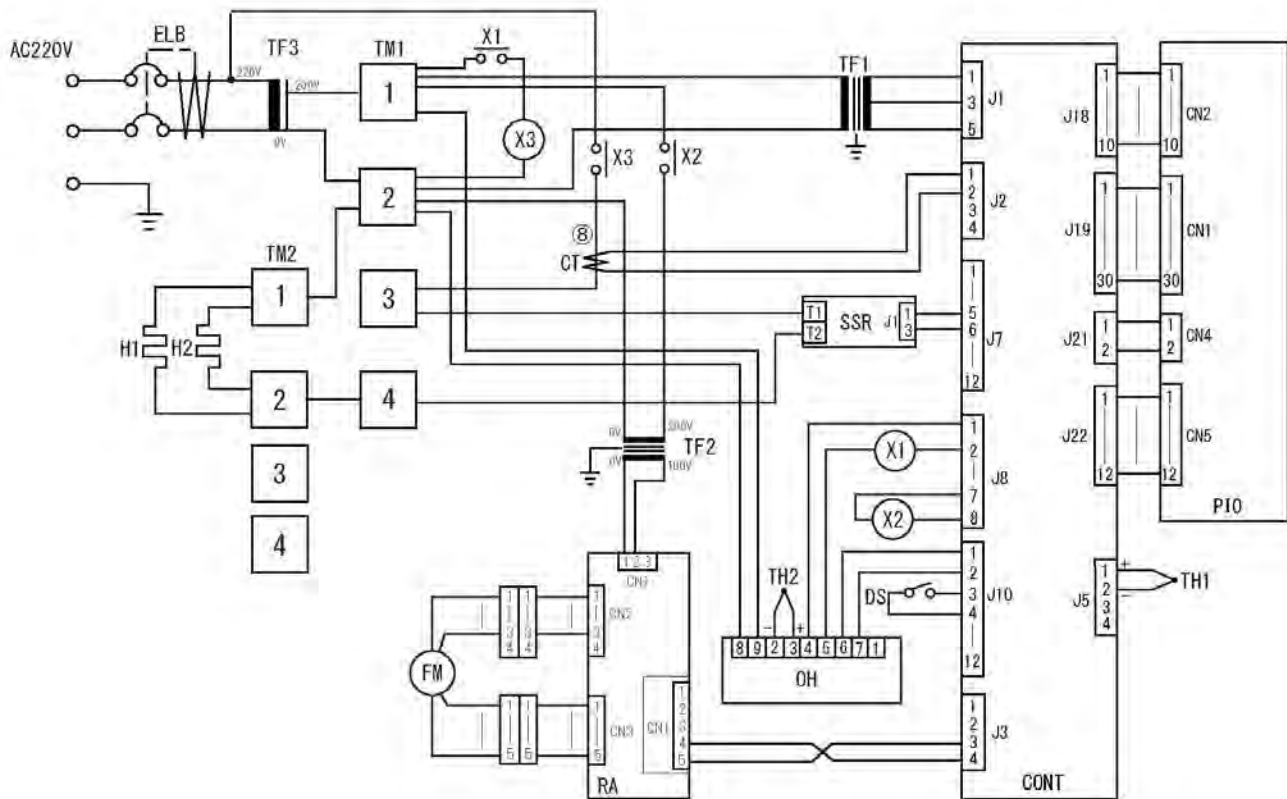

Symbol	Part name	Symbol	Part name
ELB	Earth leakage breaker	SSR	Triac
FM	Fan motor	OH	Independent overheating prevention device
H1/H2	Heater	CT	Current transformer
TM1/TM2	Terminal block	TH1/TH2	Temperature sensor (K thermocouple)
TF1/2/3	Transformer	CONT	PLANAR board
X1	Relay (heater)	PIO	Display circuit board
X2	Relay (fan)	DC/RA	Fan controller
DS	Door switch	TF	Transformer

DNF910

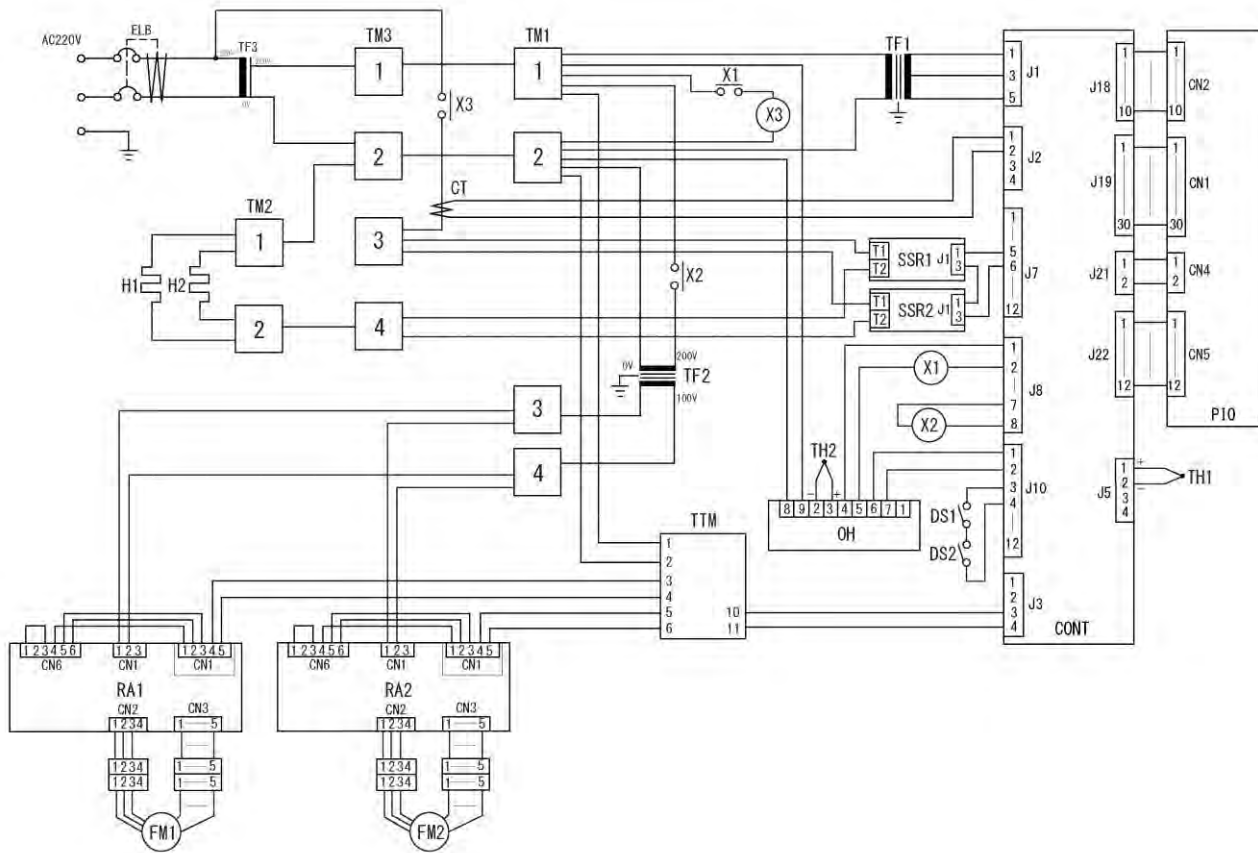

Symbol	Part name	Symbol	Part name
ELB	Earth leakage breaker	SSR1/SSR2	Triac
FM1/FM2	Fan motor	OH	Independent overheating prevention device
H1/H2	Heater	CT	Current transformer
TM1/TM2	Terminal block	TH1/TH2	Temperature sensor (K thermocouple)
TF1/2/3	Transformer	CONT	PLANAR board
X1/X3	Relay (heater)	PIO	Display circuit board
X2	Relay (fan)	DC1/DC2 RA1/RA2	Fan controller
DS1/DS2	Door switch		
TF	Transformer		

Replacement Parts Table

Common parts

Symbol	Part Name	Code No.	Specification	Manufacturer
X1/X2	Relay	2050000013	AHN36006	Panasonic
OH	Independent overheating prevention device	2100110002	PAS3K1A1-0B0	Yamato Scientific
CT	Current transformer	2170010002	CTL-6-S-4-H	URD
TH1/TH2	Temperature sensor (K thermocouple)	1160030054	LCK-M1-2000-M	Yamato Scientific
CONT	PLANAR board	1240000120	Hitec IV CR2	Yamato Scientific
PIO	Display circuit board	LT00027240	PIO12	Yamato Scientific
FM1/FM2	Motor	LT00024580	30W	Yamato Scientific
DS1/DS2	Door switch	LT00036053	UPM-17305UF	Sanyu
DC1/DC2 RA1/RA2	Fan controller	LT00024581	DC10V-24V	Yamato Scientific

DNF400

Symbol	Part Name	Code No.	Specification	Manufacturer
ELB	Earth leakage breaker	DN104	BJS1532N 15A	Panasonic
H	Heater	DNF4030020	115V 1.25kW	Yamato Scientific
TF1	Transformer	2180000040	IVCR2 100V	Yamato Scientific
TF2	Transformer	LT00036028	LZ11-100E2	Toyozumi
TF3	Transformer	LT00018189	UD11-200A2	Toyozumi
TM	Terminal block	LT00035672	MKH-250ABC-4P	Terminal
SSR	Triac	LT00028423	SSR-01	Yamato Scientific
	Power cord	LT00008924	T2-3c	Yamato Scientific

DNF410

Symbol	Part Name	Code No.	Specification	Manufacturer
ELB	Earth leakage breaker	LT00028200	BJS1032S-Z	Panasonic
H	Heater	DNF4030270	220V 1.25kW	Yamato Scientific
TF1	Transformer	2180000042	IVCR2 200V	Yamato Scientific
TF2	Transformer	LT00036029	LD21-100E2	Toyozumi
TF3	Transformer	LT00023099	UD22-200A2	Toyozumi
TM	Terminal block	LT00035672	MKH-250ABC-4P	Terminal
SSR	Triac	LT00028423	SSR-01	Yamato Scientific
	Power cord	DN129	T2-3b-0	Yamato Scientific

DNF600

Symbol	Part Name	Code No.	Specification	Manufacturer
ELB	Earth leakage breaker	2060050002	BJS2032N 20A	Panasonic
H	Heater	DNF6030020	115V 1.5kW	Yamato Scientific
TF1	Transformer	2180000040	IVCR2 100V	Yamato Scientific
TF2	Transformer	LT00036028	LZ11-100E2	Toyozumi
TF3	Transformer	LT00018189	UD11-200A2	Toyozumi
TM	Terminal block	LT00035672	MKH-250ABC-4P	Terminal
SSR	Triac	LT00028423	SSR-01	Yamato Scientific
	Power cord	2130010010	T2-3d	Yamato Scientific

Replacement Parts Table

DNF610

Symbol	Part Name	Code No.	Specification	Manufacturer
ELB	Earth leakage breaker	DN104	BJS1532N 15A	Panasonic
H	Heater	DNF6030270	220V 1.5kW	Yamato Scientific
TF1	Transformer	2180000042	IVCR2 200V	Yamato Scientific
TF2	Transformer	LT00036029	LD21-100E2	Toyozumi
TF3	Transformer	LT00023099	UD22-200A2	Toyozumi
TM	Terminal block	LT00035672	MKH-250ABC-4P	Terminal
SSR	Triac	LT00028423	SSR-01	Yamato Scientific
	Power cord	2130010010	T2-3d	Yamato Scientific

DNF810

Symbol	Part Name	Code No.	Specification	Manufacturer
ELB	Earth leakage breaker	2060050002	BJS2032N 20A	Panasonic
H1/H2	Heater	DNF8130020	220V 1.35kW	Yamato Scientific
TF1	Transformer	2180000042	IVCR2 200V	Yamato Scientific
TF2	Transformer	LT00036029	LD21-100E2	Toyozumi
TF3	Transformer	LT00023099	UD22-200A2	Toyozumi
TM1	Terminal block	LT00035672	MKH-250ABC-4P	Terminal
TM2	Terminal block	LT00035672	MKH-250ABC-4P	Terminal
SSR	Triac	LT00028423	SSR-01	Yamato Scientific
	Power cord	DN105	T2-3c-0	Yamato Scientific

DNF910

Symbol	Part Name	Code No.	Specification	Manufacturer
ELB	Earth leakage breaker	2060050002	BJS2032N 20A	Panasonic
H1/H2	Heater	DNF9130020	220V 1.65kW	Yamato Scientific
TF1	Transformer	2180000042	IVCR2 200V	Yamato Scientific
TF2	Transformer	LT00036030	LD21-200E2	Toyozumi
TF3	Transformer	LT00023099	UD22-200A2	Toyozumi
TM1	Terminal block	LT00004736	ATK-20-4P	Toyogiken
TM2	Terminal block	LT00035672	MKH-250ABC-4P	Terminal
TM3	Terminal block	LT00004704	ATK-20-2P	Toyogiken
SSR1	Triac	LT00028427	SSR-01A	Yamato Scientific
SSR2	Triac	LT00028425	SSR-01B	Yamato Scientific
	Power cord	2130010010	T3-3d	Yamato Scientific

List of Dangerous Substances



Never use explosive substances, flammable substances and substances that include explosive or flammable ingredients in this unit.

EXPLOSIVE

EXPLOSIVE:	Ethylene glycol dinitrate (nitro glycol), Glycerin trinitrate (nitroglycerine), Cellulose nitrate (nitrocellulose), and other explosive nitrate esters
	Trinitrobenzene, Trinitrotoluene, Trinitrophenol (picric acid), and other explosive nitro compounds
	Acetyl hidroperoxide (peracetic acid), Methyl ethyl ketone peroxide, Benzyl peroxide, and other organic peroxides

FLAMMABLE

IGNITING:	Lithium (metal), Potassium (metal), Sodium (metal), Yellow phosphorus, Phosphorus sulfide, Red phosphorus, Celluloid compounds, Calcium carbide, Lime phosphate, Magnesium (powder), Aluminum (powder), Powder of metals other than magnesium and aluminum, Sodium hydrosulfite
OXIDIZING:	Potassium chlorate, Sodium chlorate, Ammonium chlorate, and other chlorate
	Potassium perchlorate, Sodium perchlorate, Ammonium perchlorate, and other perchlorate
	Potassium peroxide, Sodium peroxide, Barium peroxide, and other inorganic peroxide
	Potassium nitrate, Sodium nitrate, Ammonium nitrate, and other nitrate
	Sodium chlorite and other chlorites
Calcium hypochlorite and other hypochlorites	
INFLAMMABLE LIQUID:	Ethyl ether, Gasoline, Acetaldehyde, Propylene chloride, Carbon disulfide, and other flammable substances having a flash point of lower than -30°C
	Normal hexane, ethylene oxide, acetone, benzene, methyl ethyl ketone, and other flammable substances having a flash point of -30°C or higher but lower than 0°C
	Methanol, Ethanol, Xylene, Pentyl acetate (amyl acetate), and other flammable substances having a flash point of 0°C or higher but lower than 30°C
	Kerosene, Light oil (gas oil), Oil of turpentine, Isopentyl alcohol (isoamyl alcohol), Acetic acid, and other flammable substances having a flash point of 30°C or higher but lower than 65°C
FLAMMABLE GAS:	Hydrogen, Acetylene, Ethylene, Methane, Propane, Butane, and other flammable substances which assume a gaseous state at 15°C and 1 atm

(Source: Appendix Table 1 of Article 6 of the Industrial Safety and Health Order in Japan)

Responsibility

Please follow the instructions in this document when using this unit. Yamato Scientific has no responsibility for the accidents or breakdown of device if it is used with a failure to comply. Never conduct what this document forbids. Unexpected accidents or breakdown may result in.

Note

- ◆ The contents of this document may be changed in future without notice.
- ◆ Any books with missing pages or disorderly binding may be replaced.

Instruction Manual for
Forced Convection Constant Temperature Oven
Model DNF400/410/600/610/810/910
Second Edition July 16, 2015
Revision

Yamato Scientific America, Inc.

925 Walsh Avenue, Santa Clara,
CA 95050, U.S.A

<http://www.yamato-usa.com>

Toll Free: 1-800-2-YAMATO(1-800-292-286)